

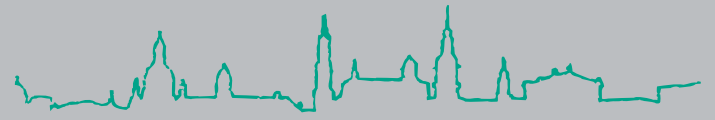

Fraunhofer

IWS



Dresden



FRAUNHOFER INSTITUTE FOR MATERIAL AND BEAM TECHNOLOGY IWS

ANNUAL REPORT 2013

www.iws.fraunhofer.de



ANNUAL REPORT 2013

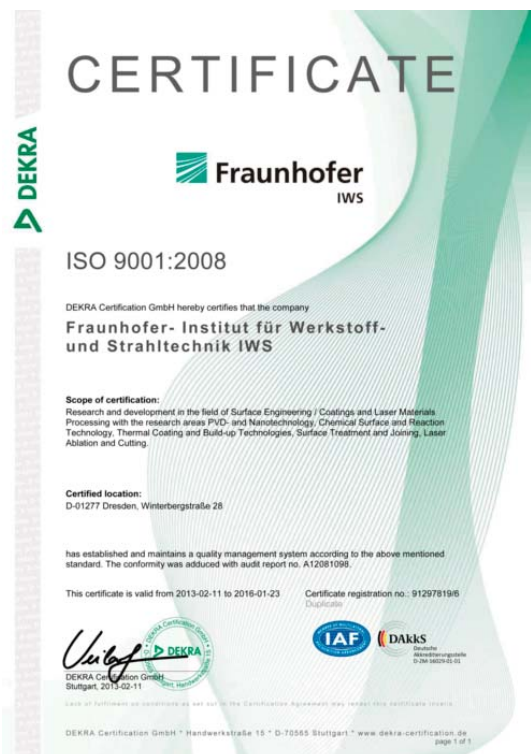

EXECUTIVE DIRECTOR PROF. DR. RALF ECKHARD BEYER



FOREWORD

*"It is the word we speak that represents the bridge
over which people come together"*

Erna Endres

Germany's economic situation was relatively stable in 2013. The IWS balance sheet was positive as well. We managed to sustain the high level of results similar to previous years although 2012 was characterized by an extraordinary budget increase.

But the year was also marked by other highlights. The institute's reputation and scientific results were recognized in various ways. Three IWS scientists received professorships from the Dresden University of Applied Sciences. Another colleague was offered an open topic tenure track professor position at the TU Dresden. IWS received additional acknowledgements such as the German High Tech Champions Award, the Masing Memorial Prize from the German Society for Materials Sciences, the Dorothy Hegarty Award as well as an honorary doctorate from the TU Wroclaw.

A number of large projects were acquired in 2013. The project "Additive Generative Manufacturing – The 3D Revolution for Product Fabrication in the Digital Age" was approved within the federal program "Twenty20 – Partnership for Innovation". IWS leads the initiating consortium, which will receive grant funding of approximately 45 million Euros (+ 45 million Euros from industry participation) over the next seven years. Other large projects are PEGASUS II with 13 partners working on low friction coatings, and the battery project BamoSa, which is coordinated by IWS and includes DRESDEN-concept partners from non-university research institutions and the TU Dresden.

As targeted we commercialized numerous IWS developments in 2013 that originated from projects with industrial partners. Some of these highlights we would like to present in this Annual Report.

In recent years the IWS has focused activities on energy technologies and energy efficiency. Today these topics are more important than ever and will also shape 2014, which we look forward to with optimism.

As always, I would like to thank all project partners for their trust and collaboration.

CONTENTS

THE FRAUNHOFER IWS

FOREWORD	3
CONTENTS	4
2013 HIGHLIGHTS	6
FROM THE BOARD OF TRUSTEES	10
INSTITUTE PROFILE	12

BUSINESS FIELDS

CHEMICAL SURFACE AND REACTION TECHNOLOGY	20
NEW TECHNOLOGIES IMPROVE SURFACE FUNCTIONALITY	
PVD VACUUM COATING TECHNOLOGY	40
NOVEL COATING SYSTEMS EXPAND THE APPLICATION SPECTRUM	
THERMAL COATING AND ADDITIVE MANUFACTURING	54
SYMBIOSIS OF COATING TECHNOLOGY AND MATERIALS SCIENCE	
JOINING	68
JOINING TECHNOLOGIES FOR METALLIC AND NON-METALLIC MATERIALS	
ABLATION AND CUTTING	86
THE LASER TOOL FOR CUTTING AND MICROMACHINING	
SURFACE TECHNOLOGY	104
HOLISTIC APPROACH TO MATERIALS, PROCESSES AND SYSTEMS	



CENTERS, NETWORKS, AWARDS

CENTERS	116
BATTERY RESEARCH CENTER	117
TAILORED JOINING CENTER	118
LASER INTEGRATION CENTER	119
NANOTECHNOLOGY CENTER	120
CARBON TECHNOLOGY CENTER	121
COMPOSITE TECHNOLOGY CENTER	122
MEDICAL AND BIOSYSTEMS ENGINEERING CENTER	123
NANTUBES AND PARTICLES CENTER	124
PROCESS MONITORING AND SENSING CENTER	125
SURFACE CENTER DORTMUND (DOC®)	126
PROJECT CENTER WROCLAW (PCW)	128
CENTER FOR COATINGS AND LASER APPLICATIONS (CCL)	130
NETWORKS	132
THE FRAUNHOFER GESELLSCHAFT	133
FRAUNHOFER GROUP LIGHT & SURFACES	134
EXCELLENT COOPERATION PARTNER: TU DRESDEN	136
DRESDEN INNOVATION CENTER ENERGY EFFICIENCY	138
SPECIAL EVENTS	140
AWARDS AND HONORS	142
PUBLICATIONS	144
ADDRESS AND DIRECTIONS	150
IMPRINT	151



EU PROJECT PLIANT STARTED

A European consortium was formed under Fraunhofer IWS leadership to push forward applications and technologies related to nanostructured surfaces. The 13.4 million Euro project "PLIANT - Process Line Implementation for Applied Surface Nanotechnologies" was started in February 2013. The object is to further expand Europe's scientific and production technical leadership by developing innovative nano and surface technologies. The competences of 13 companies, 5 research institutions and 3 universities from 8 countries are combined to form a strong research team.

CENTER FOR BATTERY RESEARCH IS EXPANDING

In June 2013, the Center for Battery Research in Dresden announced another success. Over the next three years 8 million Euros will flow from federal sources to the state capital to drive forward materials science and process research and development related to electric energy storage devices. These federal funds will pay for 864 scientific personnel months at several non-university research institutions and the Technische Universität Dresden.

Project Management Jülich supervises the project BamoSa (WING-Center: Battery-Mobile in Saxony), which is funded by BMBF. The project focuses on the development of materials and manufacturing concepts for cobalt free lithium ion cells as well as on the development of new materials and cell concepts for lithium sulfur based cells. Three research groups perform the work across several institutions. The topics include cell morphology, cell design and analytics as well as cell processing. The results will be evaluated in three industry projects.

TWENTY20 – PARTNERSHIP FOR INNOVATION

Designing products on a computer and then completely fabricating them directly in an automated process without any additional intermediate steps is just one of the visions of the project "Additive-generative Manufacturing". A consortium of 40 partners led by Fraunhofer IWS has the goal to make additive-generative manufacturing a key technology and to forge a strong network between industry and research institutions. The Federal Ministry for Education and Research will provide up to 45 million Euros over the next seven years to support research and development in this central innovation sector of materials and manufacturing technologies.

ENERGY EFFICIENCY IN MANUFACTURING

The fabrication of friction reducing carbon coatings will remain an important Fraunhofer IWS research topic in the coming years. The BMWi network project PEGASUS was completed in July 2013 and work on the follow-up project PEGASUS II began immediately. The new project is BMWi funded for a period of 3 ¼ years with a total of 20 million Euros and supports 8 companies and 3 Fraunhofer institutes.

THERMOELECTRIC ENERGY RECOVERY

November 2013 marked the start of the EU funded project NanoCaTe. Fraunhofer IWS is coordinating this effort, which combines the work of 5 companies, 4 universities and 3 research institutions from 5 European countries to develop innovative nanostructured carbon materials to fabricate energy self-sufficient wireless sensors as well as energy harvesters. The project will run over 4 years and has a total budget of 5.5 million Euros.

2013 HIGHLIGHTS



SERIES PRODUCTION LAUNCHED FOR INSTRUMENT MEASURING BARRIER MATERIALS PERFORMANCE

Measuring the water vapor transmission rates of ultra-barrier materials used to require a substantial technological effort and was also plagued by high measurement uncertainties. Fraunhofer IWS technologies now facilitate the reliable measurement of water vapor transmission rates lower than $10^{-4} \text{ g m}^{-2} \text{ d}^{-1}$. It is now in particular possible to easily and reliably measure ultra-barrier materials used in OLED fabrication, which operate at water vapor transmission rates in the range of $10^{-6} \text{ g m}^{-2} \text{ d}^{-1}$. The detection limit was improved by almost two orders of magnitude. This was achieved by combining a highly sensitive laser spectroscopic detection of the water vapor with a precise measurement protocol. The technology was implemented in a tabletop unit. The system covers a wide range of measurement parameters (temperature: 10 - 50 °C; provided humidity: 50 - 100 % r. h.) as well as a wide dynamic range from 100 to $10^{-6} \text{ g m}^{-2} \text{ d}^{-1}$. In close collaboration with the industry partner Semper Systems GmbH, the system is now commercially available under the brand name "HiBarSens®".

INFRASORP®, THE MEASUREMENT INSTRUMENT FOR HIGH THROUGHPUT SCREENING IN POROUS MATERIALS

Porous, yes or no? This question can be answered within minutes simultaneously for up to 12 samples. There is no need anymore to use conventional and relatively slow and in series working measurement techniques. A single short-term measurement is sufficient to determine and classify the adsorption capacity of up to 12 samples in parallel. This Fraunhofer IWS technology is ideal for quality control and the determination of specific surface areas and adsorption capacities of the samples. Development partner Rubotherm GmbH is leading the commercialization of this Fraunhofer IWS technology. The market entry was started in 2013 using the brand name InfraSORP.

PRODUCTION LAUNCH OF SELF-SHARPENING KITCHEN KNIVES

Fraunhofer IWS engineers developed the prototype of self-sharpening knives based on bionic principles. The knives are coated on one side with an extremely hard and tetrahedrally bonded carbon film (ta-C). In close collaboration with Fissler GmbH the team improved the process. Production costs and product quality were optimized to launch series production. In 2013 two variants (Santoku and European kitchen knife) of the self-sharpening kitchen knife successfully entered the market (see pages 46/47).

LASER INTEGRATED MILLING CENTER FOR ADDITIVE-GENERATIVE MANUFACTURING

In collaboration with the company Sauer Lasertec, Fraunhofer IWS engineers upgraded a CNC milling machine tool with laser powder buildup welding technology. This innovative manufacturing center is now ready for laser generative part fabrication. The Fraunhofer IWS systems and process technology was intelligently linked with the milling finishing process. In this way complex metallic parts can be built directly from 3D CAD data with a high degree of geometrical freedom. The machine was publicly shown at Euromold 2013 and received extraordinary resonance.

POWDER NOZZLES AND WIRE COATING HEAD FOR BUILDUP WELDING

In 2013 another 25 laser processing heads for powder and wire buildup welding processes were installed at manufacturing companies in Europe, Asia and North America. Typical applications are large area coatings for the mining, energy generation and oil production industries. But there is also an increasing demand for high precision and micro buildup welding processes. Fraunhofer IWS engineers provide training to companies on how to use the technology.

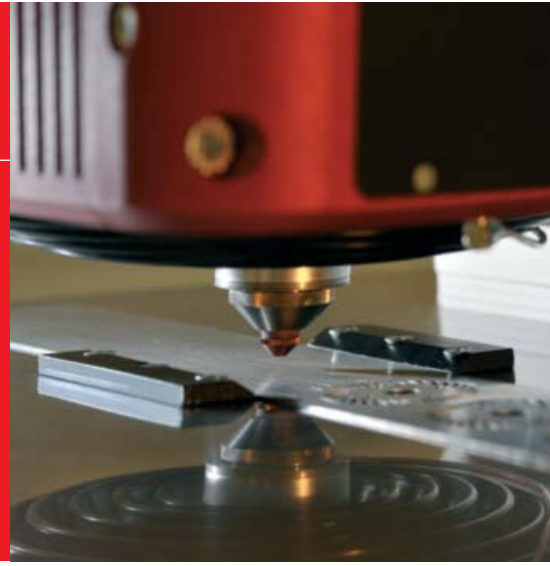

LASER MSG HYBRID WELDING MACHINE TO WELD LONGITUDINAL SEAMS FOR MOBILE CRANE COMPONENTS

The Fraunhofer IWS project group at the Surface Technology Center Dortmund (DOC®) transferred a laser MSG hybrid welding machine as well as a manual tack-welding machine to the company KSK-Vlassenroot in Schwerte. The hybrid system is 19 m long and based on a large portal plant by the company Reis. It is equipped with a 12 kW fiber laser and sensor for automatic seam tracking.

The plant is currently welding telescoping tubes for mobile cranes up to a height of 180 m. The tubes are made from highest strength fine-grained steel with a sheet thickness of 4 - 12 mm. Two half-shells are welded with two longitudinal seams. Prior to the hybrid welding process the shells are tack-welded by hand. Due to the automatic seam tracking feature and the flexible manual tack-welding, it is also possible to weld other steel construction components with minimized warpage. Fraunhofer IWS engineers, who also helped to setup and startup the machine, performed process development and supported the production launch.

HIGHLY DYNAMIC CUTTING WITH FIBER LASERS – FIRST TIME INDUSTRY INTRODUCTION

Fraunhofer IWS industry partner Scheuermann + Heilig is an internationally leading manufacturer of stampings, stamped-bent parts and assembly components. The company collaborated with Fraunhofer IWS engineers to deploy a highly dynamic form cutting (HDFC) laser fusion process and remote laser cutting of stampings and bent parts in their manufacturing line. Pre-series fabrication with HDFC has begun and first parts have been shipped to a customer from the automotive industry.

As opposed to a classic laser cutting process, the cycle times are closer to traditional stamping processes. However, compared to stamping, the laser offers a larger degree of freedom to select the form of the part. The laser also operates without wear, which reduces high tooling costs and avoids unplanned production shutdowns due to tool failure.

LASER HARDENING MACHINE FOR STEAM TURBINE BLADES FOR FUJI ELECTRIC, JAPAN

Since July 2013, Fuji Electric in Kawasaki, Japan has been operating a laser beam hardening system for steam turbine blades for power plants. Fuji is the second industry customer worldwide to do so. Fraunhofer IWS engineers support the setup of the plant with development and delivery of process adapted core components. The dynamic beam shaping system "LASSY" tailors hardening zones according to the loading in the areas of the blade edges. The system works in combination with spatially resolved temperature measurements and the especially for laser processes developed "LompocPro" controller.

MEASUREMENT AND CONTROL SYSTEM FOR LASER PROCESSES

A total of 6 camera-based temperature measurement systems of the type "E-MAqS" were installed at manufacturers in 2013. Four companies and one research institution are using these systems in combination with "LompocPro" controllers for laser processes such as hardening, soldering and buildup welding. Fraunhofer IWS engineers support technology development and equipment setup at the companies Alotec Dresden (hardening), Bekaert in Belgium (laser beam buildup welding), Fuji Electric in Kawasaki (laser beam hardening), System S.A. in Kattwice, Poland (hardening and buildup welding) as well as the BIAS institute in Bremen (laser soldering).

FROM THE BOARD OF TRUSTEES



The Board of Trustees consults and supports the institute's management and the bodies of the Fraunhofer-Gesellschaft. The 23rd Board of Trustees meeting occurred on March 22nd, 2013 at the Fraunhofer IWS in Dresden. The following members were active in the Board of Trustees during the reporting period:

FRANK JUNKER, DR.

Chairman of the Board of Trustees,
Independent Consultant,
Radebeul

REINHOLD ACHATZ, DR.

ThyssenKrupp AG,
Manager Corporate Technology, Innovation & Quality,
Essen

DIETER FISCHER

Chief Executive Officer,
EMAG Leipzig Manufacturing Systems GmbH,
Leipzig

PETER KÖSSLER

Plant Manager AUDI AG,
Ingolstadt

UWE KRAUSE, DR.

Karlsruhe Institute of Technology,
Project Management Agency Karlsruhe,
Production and Manufacturing Technologies,
Branch Office Dresden

HANS MÜLLER-STEINHAGEN, PROF. DR.

Rector (President), Technische Universität Dresden

PETER G. NOTHNAGEL

Chief Executive Officer,
Saxony Economic Development Corporation GmbH,
Dresden

MARKUS RALL, DR.

Chief Executive Officer,
Adolf Mohr Machine Factory GmbH & Co. KG,
Hofheim/Taunus

HERMANN RIEHL, MINR

Federal Ministry of Education and Research,
Head of Department Production Systems and Technologies,
Bonn

CHRISTOPH ULLMANN, DR.

Chief Executive Officer,
Laserline GmbH,
Mühlheim-Kärlich

RENÉ UMLAUFT, DR.

Speak of the Board of Directors, MAN Diesel & Turbo SE,
Augsburg

FRANZ-JOSEF WETZEL, DR.

BMW Motorrad, Business Sector Planning, Cooperation,
Munich

PETER WIRTH, DR.

Rofin-Sinar Laser GmbH,
Hamburg

REINHARD ZIMMERMANN, MINR DR.

Saxony State Ministry of Science and the Arts,
Dresden



“Basically completely positive and better than expected” answered a good friend and economics expert, when I asked him to provide his assessment of 2013. His appraisal is in agreement with my very own. Economic activities developed very well overall except for some minor branches. The positive overall development is based on substantial exports that remain strong in many areas. This is a good basis for the future, even if all European countries do not share this positive view. The export opportunities for Germany continue to remain strong despite the ongoing financial crisis. Europe in particular is again gaining confidence in the future.

Politics made 2013 a very tense year. The results however are viewed mostly positively after the elections and subsequent tenacious coalition negotiations. It is hoped that the general framework matches the expectations of the industry. This is also an important foundation for the institutes of the Fraunhofer-Gesellschaft.

The Fraunhofer-Gesellschaft continued its successful development in 2013. Stable industry inquiries for research and development services drove the growth. This also reflects the quality of the research services for the German economy. The Fraunhofer Society also continued to expand its international engagements and networks. This is an important starting point to organize scientific cooperation with the best international partners.

The Fraunhofer-Institut für Werkstoff- und Strahltechnik IWS was very successful in 2013. The contract situation was stable with continuing demand for research services. The research results demonstrated the high level of innovation capability of the institute. The IWS research results also contributed to the economic strength and the global competitiveness of its industry partners.

Highly innovative projects are being performed with clear benefits to the customer. Research foci in surface and laser technologies, battery technology and material systems, and energy storage technologies are being further refined.

The DRESDEN-concept science network successfully connects basic research at the Technische Universität, the Max Planck Institutes, the Leibnitz Institutes and the Helmholtz-Center with the applied research of the Fraunhofer Institutes.

The IWS satellite operation in the USA and the project partner in Wroclaw, Poland, also developed positively in 2013.

On November 15, 2013 institute director Prof. Eckhard Beyer received an honorary doctorate from the Technical University Wroclaw for his scientific contribution and engagement during the buildup of a joint education and research center for laser technology with the Technical University Wroclaw. We, the trustees, are very pleased about this honor and cordially congratulate Prof. Eckhard Beyer and the institute to have received this appreciation.

We are extraordinarily pleased with the institute's development in 2013 and await with excitement the further strategic orientation. The Board of Trustees expresses its gratitude to the customers for their trust and to all institute employees and partners for their collaboration and the achieved results. We wish you a healthy and successful future.

Yours truly,
Dr. Frank Junker

CORE COMPETENCES

The transfer of current research results into industrial practice is an essential driving force for research efforts at the institute. To adequately meet this "mission" we have developed and continually expanded core competences in the following areas:

LASER MATERIALS PROCESSING

- high speed cutting of metals
- cutting and welding of plastics and other non-metals
- welding processes for hard-to-weld materials
- laser buildup welding and generating
- laser surface hardening, remelting and alloying in particular for highly stressed and complex components
- rapid heat treatments
- laser hybrid technologies, e.g.
 - laser induction welding and buildup welding
 - plasma, TIG or MIG assisted laser beam welding and buildup welding
- ablation, cleaning and structuring
- process specific monitoring and control

SURFACE FUNCTIONALIZATION AND COATING

- plasma, arc and flame spray processes with powder and suspensions
- high rate coating processes (vacuum arc, electron beam evaporation)
- laser arc process as a hybrid technology
- plasma and chemical etching, ablation, cleaning and functionalization
- chemical vapor deposition
- paste deposition (also in roll-to-roll process)
- spray deposition of ultrathin coatings
- nano and micro structuring

SYSTEMS TECHNOLOGY

- implementation of process know-how in development, design and fabrication of components, machines and systems including associated software
- systems solutions for cutting, welding, ablation, deposition, surface refinement and characterization with laser, e.g.
 - processing optics, sensorics, beam scanning and monitoring systems including control software for high speed and precision processing
 - beam shaping systems and process control for surface refinement with high power diode lasers
- coating heads for the continuous free-directional powder or wire delivery as well as process monitoring and CAM control software
- process oriented prototype development of components and coating systems for the PVD precision and high rate deposition, the atmospheric pressure CVD as well as chemical and thermal surface refinement processes
- measurement systems for coating characterization, nondestructive component evaluation with laser acoustic and spectroscopic methods
- systems for the spectroscopic monitoring of gas mixtures
- software and control technology



MATERIALS SCIENCE / NANOTECHNOLOGY

- determination of material data for material selection, component design and quality assurance
- metallographic, electron microscopic and microanalytical characterization of the structure of metals, ceramics and coating compounds
- failure and damage analysis
- thermal shock characterization of high temperature materials
- property evaluation of surface treated, coated and welded materials and components
- optical spectroscopic characterization of surfaces and coatings (nm through mm)
- mechanical and tribological characterization
- coating thickness and Young's modulus measurements of nm to mm coatings with laser acoustics
- ellipsometry, X-ray reflectometry and diffractometry
- imaging surface analysis
- electrochemistry and electrode chemistry
- fabrication, functionalization and processing of nanoparticles and nanotubes

PROCESS SIMULATION

- in-house development of simulation modules for
 - thermal surface treatments and laser hardening
 - laser powder buildup welding
 - vacuum arc deposition
 - laser cutting and welding
- calculation of optical properties of nanocoatings with internal simulation tools
- use of commercial simulation modules for
 - laser beam welding and cutting
 - optimization of gas and plasma flows during coating processes and laser materials processing

Business fields	Core services				
	Laser materials processing	Surface functionalization and coating	Materials / nanotechnology	Systems technology	Process simulation
Ablation / cutting	■	□	□	■	□
Joining	■		■	□	□
Surface technology					
Surface layer technology	□	□	■	■	□
Thermal coating technology	□	■	□	□	□
PVD coating technology	□	■	■	□	□
Surface and reaction technology		■	□	□	□

■ core competence
 □ additional competence

DEPUTY DIRECTOR DR. ANJA TEHEL



"Little things make perfection, but perfection is not a little thing"

Sir Frederick Henry Royce

INSTITUTE DATA

IWS EMPLOYEES

	number
Staff	196
Scientists / Engineers (TU/FH)	130
Skilled workers with technical or mercantile education	57
Trainees	9
TU Dresden employees (working at the IWS)	39
Scholarship holders and external colleagues	12
Research assistants	210
TOTAL	457

IWS PUBLICATIONS

	number
Dissertations	3
Diploma theses	17
Master's theses	1
Bachelor's theses	4
Journal papers	126
TOTAL	151
Patents (first filing)	14

43 % Staff

8 % TU employees

3 % Scholarship holders and external colleagues

46 % Research assistants

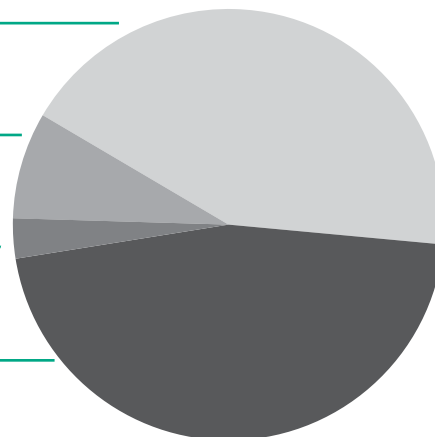

EMPLOYEES AT THE FRAUNHOFER CCL (USA) 17

Revenues 2013 (Mio. €)*	Operation	Investments	Total
Project revenues from industry	10.5 45 %	0.2 6 %	10.7 40 %
Project revenues from federal, state and European sources	7.2 31 %	0.2 6 %	7.4 28 %
Base funding and Fraunhofer internal programs	5.6 24 %	2.9 88 %	8.5 32 %
	23.3	3.3	26.6

Expenditures 2013 (Mio €)*	
Personnel costs	11.4 43 %
Material costs	11.9 45 %
Investments	3.3 12 %
	26.6

Fraunhofer industry $\rho_{Ind} = 45.9 \%$

*JANUARY 2014

GEOGRAPHICAL ORIGIN OF INDUSTRIAL REVENUES

Germany 86 %

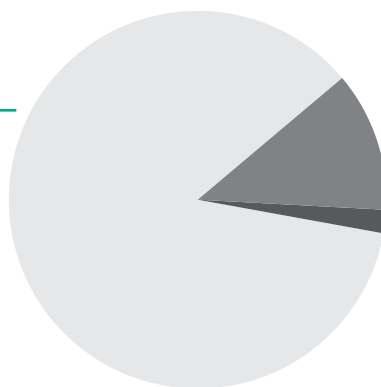

Europe 12 %

Asia 2 %

ORIGIN OF REVENUES FROM FEDERAL, STATE AND EUROPEAN SOURCES

BMBF 33 %

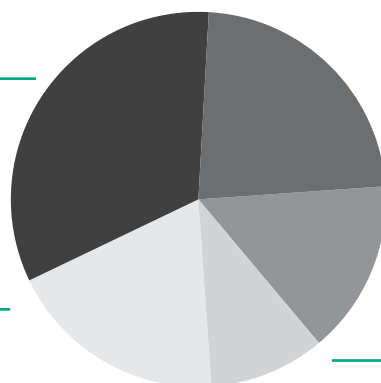

Länder 23 %

EU 15 %

Governmental agencies 19 %
(BMBF excluded)

other 10 %

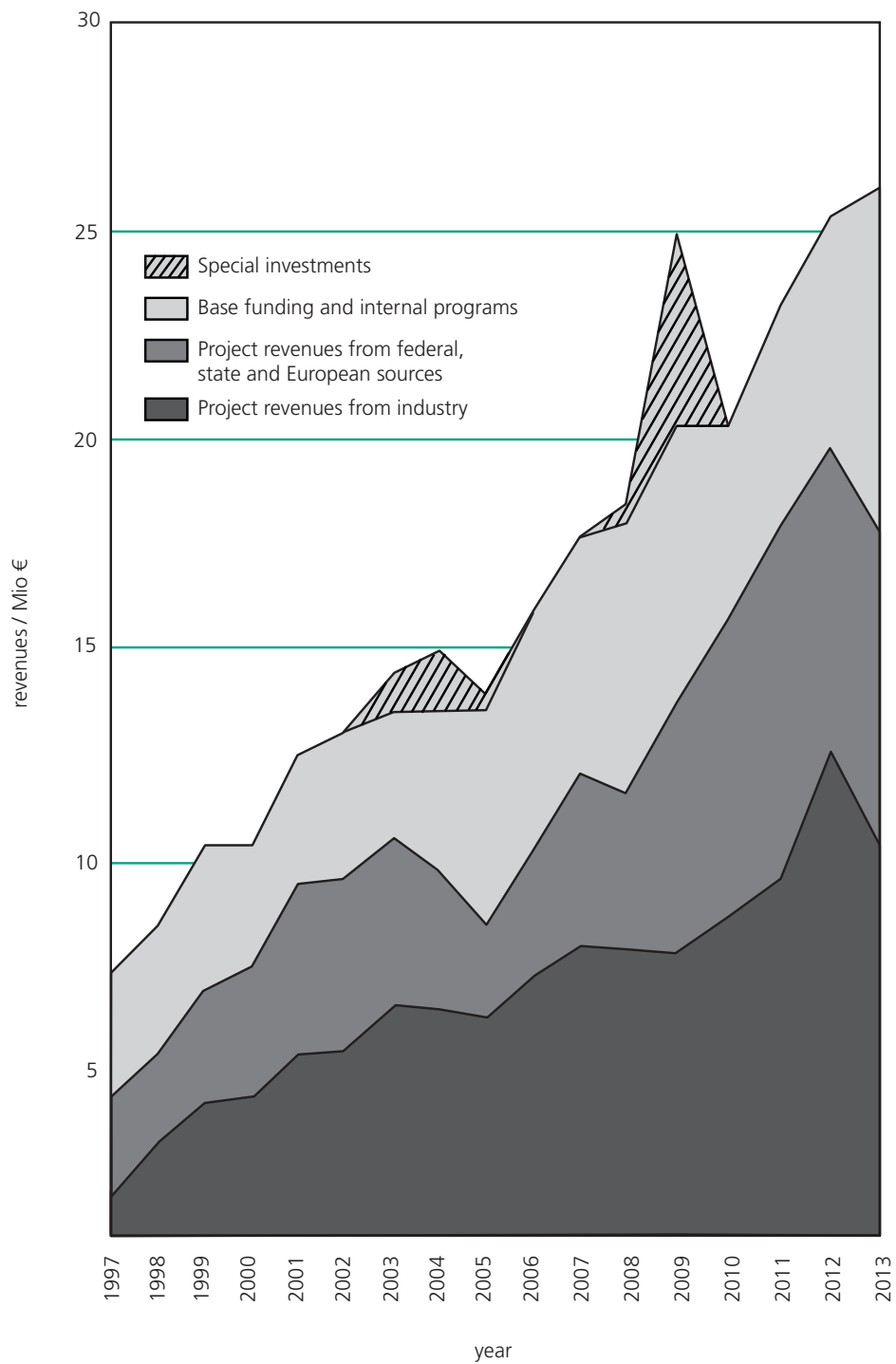

THE MANAGEMENT TEAM

"Between science and accomplishment lies a vast bridge, over which, and often only after difficult struggle, a mediatory bridge can be built."

Robert Schumann



ORGANIZATION AND CONTACTS

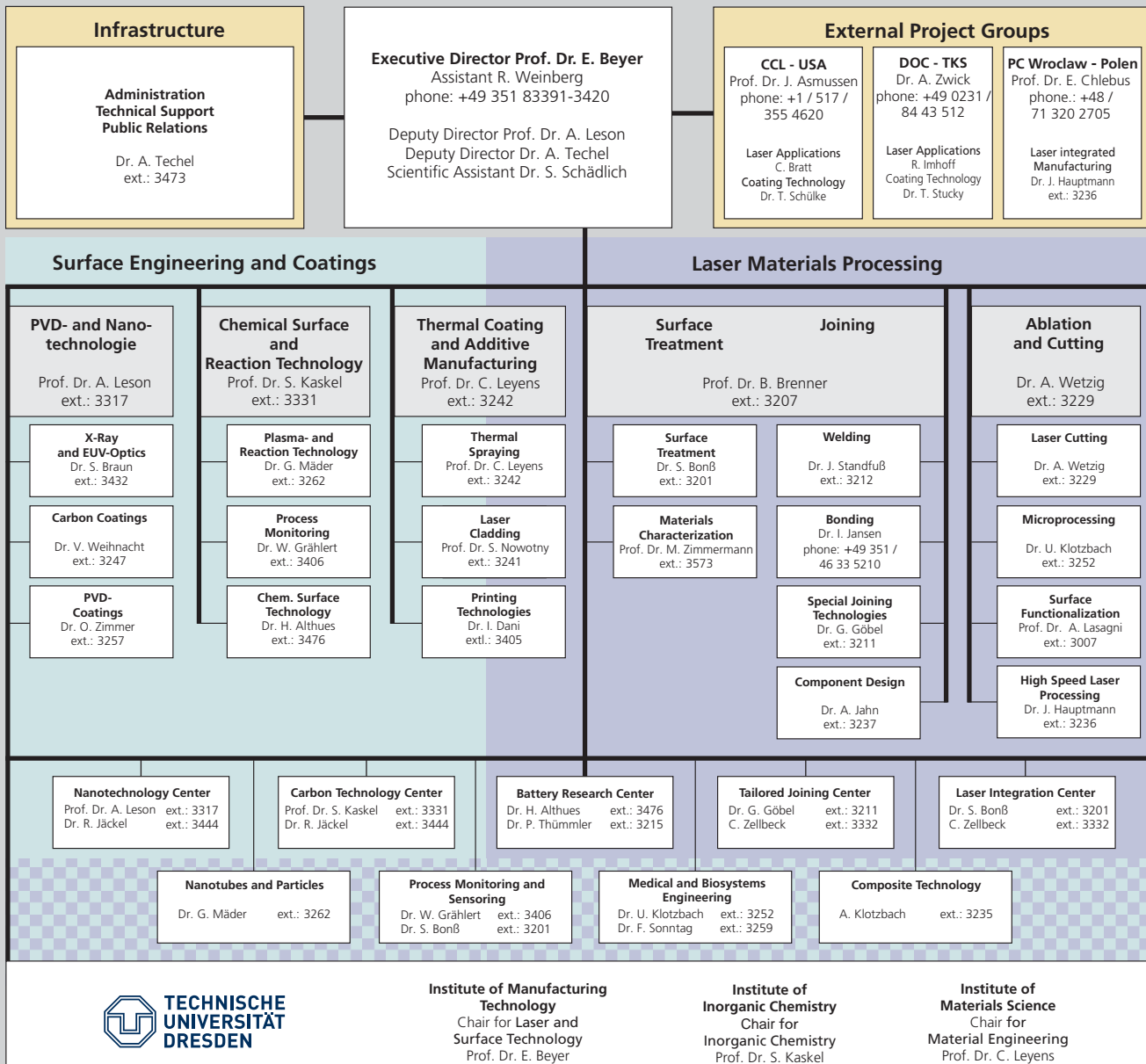

HEAD OF DEPARTMENT PROF. DR. STEFAN KASKEL



"The only remedy for superstition is knowledge"
Henry Thomas Buckle

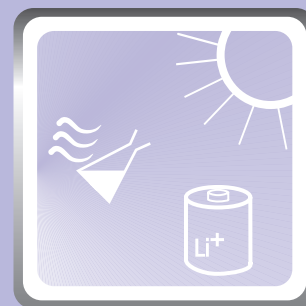

BUSINESS FIELD CHEMICAL SURFACE AND REACTION TECHNOLOGY

Editor: Prof: Kaskel, which future challenges are you pursuing?

Prof. Kaskel: Over the coming years my department will continue with dedicated ingenuity to develop metal-sulfur batteries and associated technologies. During the last year we were able to increase the stability of lithium-sulfur batteries beyond 1000 cycles and we also developed a new class of anode materials. Current work now focuses on sodium-sulfur batteries. Since sodium is a readily available resource, one can expect another significant cost reduction for such batteries. This is in particular critical for stationary applications. However, today's sodium-sulfur batteries are operating at high temperatures (300 °C), which poses significant safety risks. Our research demonstrated that it is possible for such batteries cells to also operate at room temperature. The key is to develop a new separator with an impressive capability to suppress the so-called shuttle mechanism, which is a common failure mechanism in sulfur batteries. I recommend that you come and visit one of our annual workshops on sulfur battery technologies to learn more about the current developments.

Editor: Prof: Kaskel, why are you also returning to doing more work in atmospheric pressure processes?

Prof. Kaskel: Well, coating processes at atmospheric pressure have the advantage that they do not need large vacuum equipment. Time consuming steps such as loading parts into chambers and then pumping the chamber prior to the actual coating process can be eliminated. This implies simplification

of the atmospheric pressure processes, which can also be scaled to large areas. Our LARGE plasma source meanwhile presents an attractive technology for coating and surface activation processes. An example is the preparation of 15 cm wide polymers prior to printing or bonding processes. Another application is to use the source as a spray gun for large area deposition. Here the LARGE source has advantages over conventional single nozzle systems, which only cover small areas and system costs scale quickly with an increasing number of nozzles. It is also possible to produce an entire selection of coatings by atmospheric pressure deposition including transparent and conductive oxide films, which can then be transferred to polymer surfaces.

Editor: Very interesting indeed, but what are the products?

Prof. Kaskel: Transparent conductive surfaces which have broad applications in display and photovoltaic industries. A challenge is to make those films uniform. We have developed a new imaging analytical technique to address this.

Editor: Can you tell us more about this?

Prof. Kaskel: Absolutely. The so-called Hyperspectral Imaging (HSI) provides spatially resolved chemical information about coatings and all kinds of defects on surfaces with an analysis depth of several micrometers. The technique visualizes non-uniform deposition, but it also enables failure and damage analysis as well as the detection of surface contaminations.



COMPETENCES

PLASMA AND REACTION TECHNOLOGY

Plasma based processes and chemical vapor deposition at atmospheric pressure are cost effective large area technologies. They are used for activation, cleaning or deposition of high quality functional coatings. Continuous coating processes are established for temperature sensitive materials on flat and also slightly curved substrates. The group develops reactor prototypes to deposit oxide and non-oxide coatings. Gas phase reactors are being developed to produce nanoparticles and nanotubes. Thermo-fluid dynamic modeling and experimental results are combined to optimize modular reactor designs, which offer cost effective process adaptations to new applications.

PROCESS MONITORING

Opto-spectroscopic techniques provide a superb tool for monitoring industrial production processes. Products can be characterized during or after fabrication. Various methods provide information about process atmospheres (gas composition) and product properties (surface, coatings, composition, porosity etc.). These data is obtained contact-free, with high sensitivity and sometimes even with lateral resolution. The results are exploited for automated monitoring, controlling and optimization of such processes. The group does not only work on the adaptation of existing techniques to new applications but also develops and commercializes entirely novel sensor technologies.

CHEMICAL SURFACE TECHNOLOGY

The surface properties are of special importance for the application of many materials. Functional thin film coatings, for example, provide conductive, scratch resistant or self-cleaning properties. Nanostructured materials with well-defined surface chemistry are critical to develop next generation double layer capacitors and batteries with much improved performance. The group develops both gas and liquid phase processes for large area deposition applications using new materials. Foci are transparent, functional thin films, electric energy storage devices and super capacitors.



HEAD OF DEPARTMENT

PROF. STEFAN KASKEL

phone +49 351 83391-3331

stefan.kaskel@iws.fraunhofer.de



**GROUP LEADER PLASMA
AND REACTION TECHNOLOGY**

DR. GERRIT MÄDER

phone +49 351 83391-3262

gerrit.maeder@iws.fraunhofer.de



2013 PROJECT EXAMPLES

1. Production technologies to fabricate battery cells	24
2. Ion selective membranes for stable lithium- and sodium-sulfur batteries	26
3. Transfer processes for inorganic functional coatings on polymer foils	28
4. Imaging spectroscopy in new dimensions	30
5. Fast characterization of porous materials by optical calorimetry	32
6. Plasma source for large area surface conditioning	34
7. From micro to nano: Controlled surface structuring of silicon solar wafers	36
8. Boron doped diamond electrodes for electrochemical analysis	38

**GROUP LEADER
PROCESS MONITORING**

DR. WULF GRÄHLERT

phone +49 351 83391-3406

wulf.graehlert@iws.fraunhofer.de



**GROUP LEADER
CHEMICAL SURFACE TECHNOLOGY**

DR. HOLGER ALTHUES

phone +49 351 83391-3476

holger.althues@iws.fraunhofer.de





PRODUCTION TECHNOLOGIES TO FABRICATE BATTERY CELLS

THE TASK

Production costs present a continuing challenge for the manufacturers of lithium-ion battery cells. The federal government envisions a breakthrough of electromobility technologies. To achieve the goals however, the current energy storage device costs have to be cut in half. Lithium-ion battery prices have come down in recent years while the costs of materials remained nearly constant. There is nonetheless still a substantial saving potential in high volume manufacturing of such cells.

A challenge is that electrode fabrication steps frequently use NMP, which is a toxic solvent that has to be removed and post treated using complex drying lines. Another complex processing step is the cutting of electrode shapes out of the produced sheet material. For each cut the moving sheet has to be stopped and restarted – a time consuming procedure.

All fabrication steps during lithium-ion cell manufacturing from powder processing to packaging the cells are performed in a dry air environment to minimize the exposure of the cell material and chemistry to water molecules. Typically this requires spacious walk-in dry rooms. The advantage is that workers can perform tasks directly at the machines and in close proximity to the production processes. However, maintaining dry air conditioning substantially increases costs incidental to production.

OUR SOLUTION

Improving lithium-ion battery manufacturing efficiency is a primary goal of a BMBF funded research project ("DryLIZ", project number 02PJ2302). Technologies are improved to reduce processing times and manufacturing overhead costs.

An IWS dry electrode fabrication process was expanded and improved for making new cell types. Preparation and processing steps were developed, which simplify the production of electrodes with high specific capacities for prototype pouch cells.

Currently under development is the "on-the-fly cutting" of electrodes from the sheet material without stopping the roll. Two ways are pursued to cover a broader spectrum of customer interests: mechanical rotational punching and remote laser cutting. Rotational punching is superior to conventional punching and contact-free remote laser cutting processes benefit from zero tool wear. Mechanical cutting, on the other hand, suffers from tool wear and also material transfer issues. The laser cutting process may develop smokes and splatter, which must be minimized. However, the true potential of this technology becomes apparent when considering that the 142 x 194 mm² electrodes may be cut at speeds as high as 130 m min⁻¹.



One of the tasks in the DryLIZ project is the implementation of a new dry air conditioning concept. The goal is to minimize the required dry air volume and to reduce the associated incidental production costs. The concept is to limit the volume of dried air to the actual material processing region. The implementation requires airtight sealing of the processing chambers while simultaneously minimizing the humidity introduced by workers. The overall air conditioning energy requirements can be substantially reduced.

RESULTS

The different battery cell manufacturing technologies were studied and the enormous cost reduction potential became apparent for the following steps:

- dry electrode processing, which renders the complex drying line obsolete since there are no solvents at all in the production flow
- rotating punching and remote laser cutting processes both reduce the processing time and maintain a constant material transport during the cutting
- reducing the required dry air volume to the amount needed in the actual material processing region reduces the associated facility and energy costs for air conditioning
- automation and transportation concepts demonstrate the feasibility of industrial implementation of these processes

In collaboration with project partners, IWS engineers are further developing these technologies and implementing them in prototype equipment.

In addition to DryLIZ project work, IWS engineers are also building a demonstrator machine for fabricating actual battery cells with a footprint of 3 x 8 m². All processing steps are automated and performed in dry atmosphere (dew point -20 °C) including electrode cutting and separation, electrode sheet transportation, assembly, welding and packaging of cell stacks in pouch foil. The finished cell stack leaving the machine is ready for filling with an electrolyte and final sealing.

Within a short time this machine will be available to industry partners to build prototype cells and to evaluate and market their technologies.

- 1 *Pilot pouch cell made by Fraunhofer IWS, dimensions 50 x 75 mm²*
- 2 *Automatic machine for cell stack fabrication at Fraunhofer IWS*

CONTACT

Dr. Philipp Thümmeler
 phone +49 351 83391-3215
 philipp.thuemmler@iws.fraunhofer.de



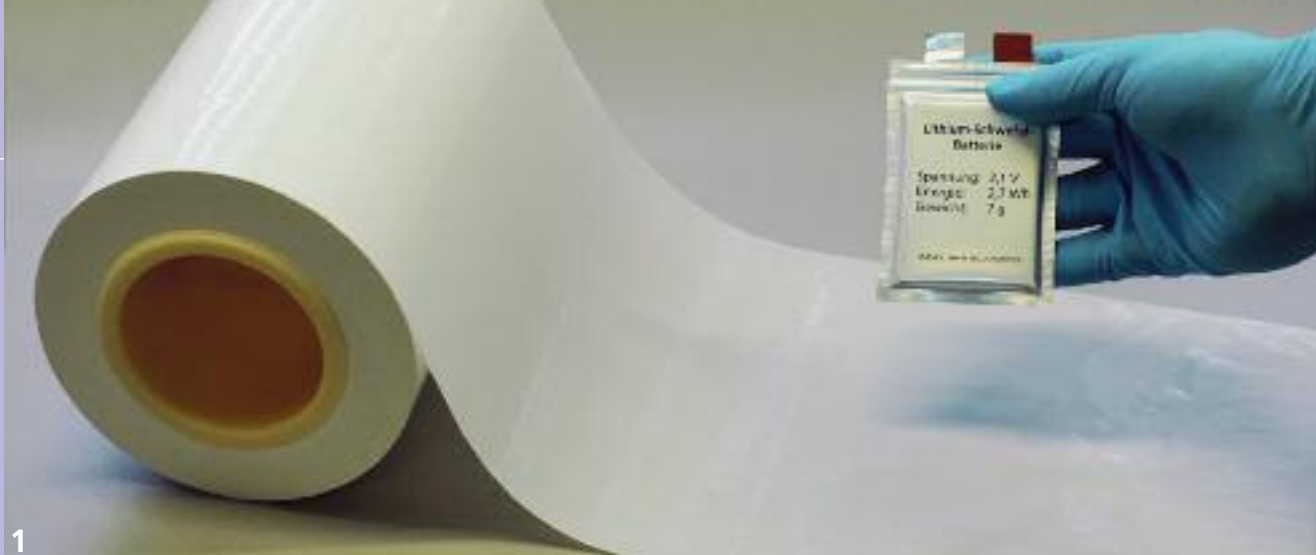

ION SELECTIVE MEMBRANES FOR STABLE LITHIUM AND SODIUM-SULFUR BATTERIES

THE TASK

Sulfur batteries are among the most promising cell systems to permanently replace lithium ion batteries for energy storage in the future. Sulfur is non-toxic and can store large amounts of electric charge. Due to its natural abundance, it is also inexpensive.

To utilize the stored electric charge sulfur has to be brought in contact with a reactant. Alkali metals such as lithium and sodium are ideal for this purpose due to their low weight and high reactivity toward sulfur. Lithium is especially suitable for automotive applications to combine high energy densities with low weights. Sodium is much more abundant and thus considerably less expensive than lithium. Therefore sodium is the preferred metal for stationary battery solutions where high energy densities are less critical.

One of the greatest common challenges in lithium and sodium-sulfur battery development is to suppress the so-called polysulfide shuttle mechanism. This mechanism describes the transfer of intermediate products in electrolyte solution, which are formed as byproducts in metal-sulfur reactions (polysulfides). The transport of such polysulfides from the sulfur electrode to the alkali metal electrode renders the otherwise electrochemically active sulfur species inactive. This ultimately leads to continuously decreasing charge storage ability of the cell.

OUR SOLUTION

The Fraunhofer IWS approach is to develop novel separators that block the negatively charged polysulfide from reaching the alkali metal electrode. Simultaneously the separators need to maintain the transport properties of the positively charged lithium and sodium ions. Possible materials are ceramics and polymers with negatively charged functional groups.

Thin ceramic plates are very selective, but costs, brittleness and an overall low conductivity for lithium and sodium ions make their use in large format batteries more difficult. The high weight of ceramic separators also reduces the energy density of the battery.

Due to their flexibility polymer materials are highly suitable separators. Nafion is a perfluorinated polymer that is functionalized with negatively charged sulfonic acid groups, and can be used to block polysulfides. However, this material in the form of freestanding membranes also suffers from unsatisfactory conductivity.

To circumvent this problem, IWS engineers apply thin Nafion films to a porous polymer carrier substrate and use it as an ion selective separator. The porous polymer material is mechanically stable and flexible. These positive properties are exploited in combination with the high ion conductivity of the thin Nafion film.

Such a separator matches commercial products in terms of weight and thickness but also reliably blocks polysulfide species. Materials costs are substantially lower compared to using freestanding Nafion membranes as the solution only requires a thin Nafion film.

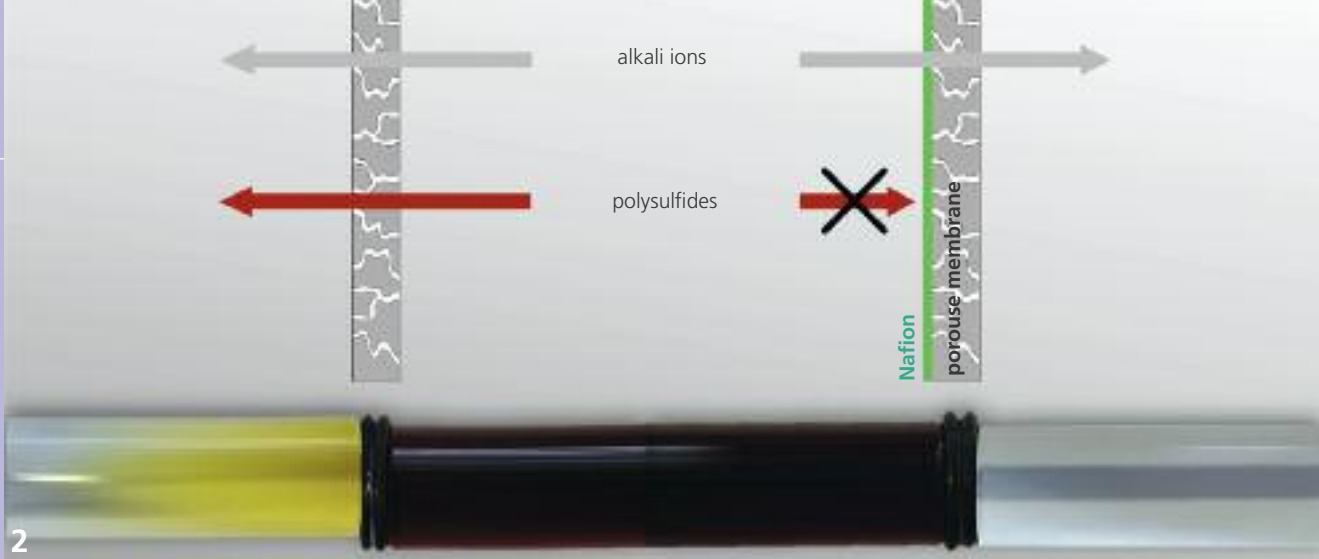

RESULTS

The technical potential of sodium-sulfur batteries can be much better exploited with a reduced polysulfide shuttle effect. IWS developed ion selective membranes led to a 75 % capacity increase in sodium-sulfur batteries at room temperature compared to batteries with conventional separators. (Fig. 3).

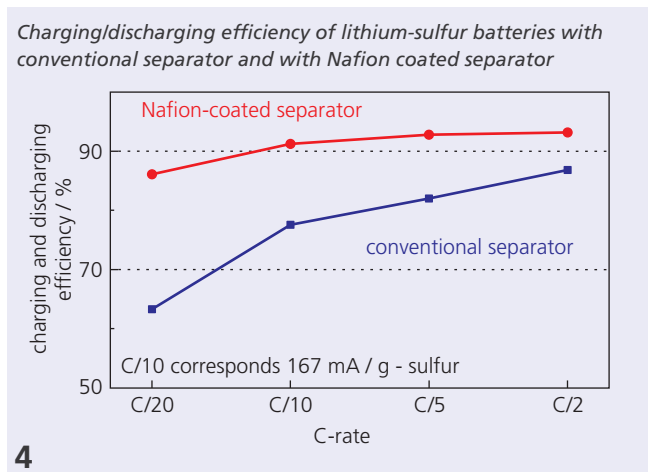
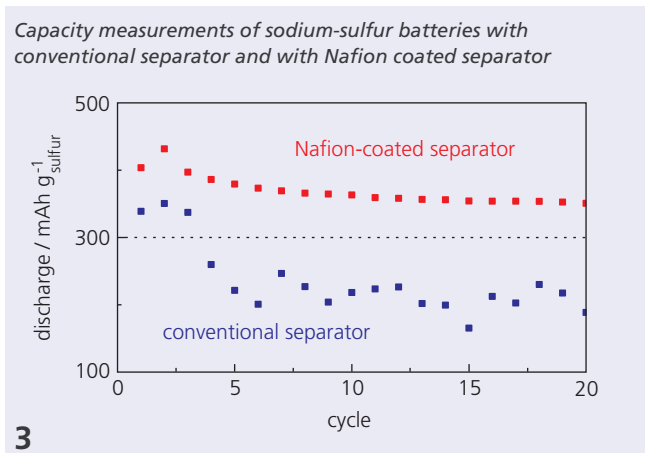

- 1 Polymer separator and lithium-sulfur pouch cell
- 2 Blocking of polysulfides

In lithium-sulfur batteries the IWS Nafion separators increase the charging/discharging efficiencies over a wide current range (Fig. 4). During the charging process, polysulfides are not transported to the alkali metal electrodes, which prevents them from reducing. This reduces the loss of charge carriers and improves the charging/discharging efficiency.

It was also possible to demonstrate reduced self-discharging in batteries with the modified separator. This improves their storage properties.

CONTACT

Dr. Holger Althues
 phone +49 351 83391-3476
 holger.althues@iws.fraunhofer.de





TRANSFER PROCESS FOR INORGANIC FUNCTIONAL COATINGS ON POLYMER FOILS

THE TASK

The refinement of polymer foils with inorganic functional coatings creates products with a wide range of possible applications. Examples of such applications are found in technology areas of great future potential:

- foils with transparent conductive coatings for displays, solar cells and lighting elements
- barrier foils for packaging with reduced water vapor permeation
- optical functions (anti reflection, UV and IR absorption)

However, such applications demand the highest possible coating quality. Simultaneously the temperature sensitivity of the polymer limits the range of applicable coating methods. Typically low substrate temperatures imply poor coating quality (e.g. low density, low conductivity). Traditionally this correlation between temperature and quality has been very restricting to the possible combinations of coating and substrate materials.

OUR SOLUTION

IWS engineers developed a process that avoids the temperature problem by separating the actual deposition process from the substrate. Existing processes can be used with their regular temperatures and conditions to synthesize highly conductive and crystalline films.

These films are deposited onto temporary substrates and then transferred over to the actual target substrate material. This process separation makes it possible to apply the benefits of higher temperature deposition processes to temperature sensitive substrates. A wide range of material combinations can be exploited, which is impossible by direct deposition. The principle is shown in Fig. 2.

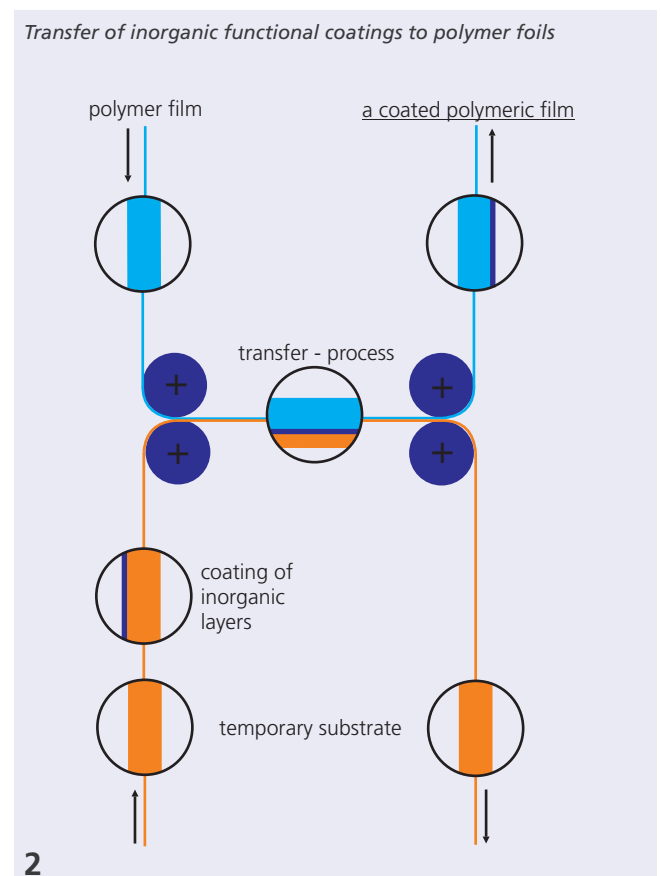

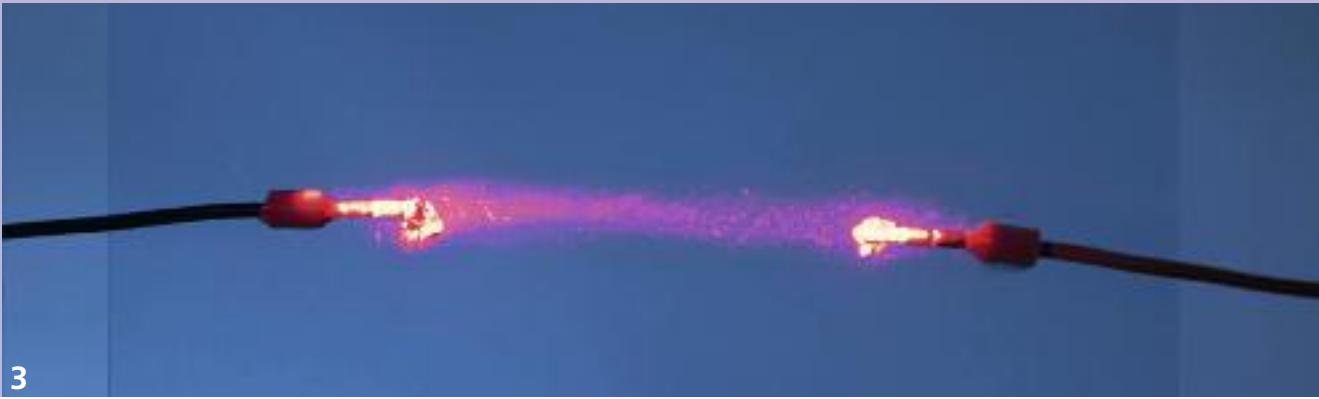

RESULTS

Chemical vapor deposition at atmospheric pressure (AP-CVD) is used to deposit transparent and conductive coatings. The coating material is fluorine doped tin oxide (FTO). The substrate temperature during this process is more than 400 °C, which is substantially higher than the decomposition temperature of most polymers. However, the IWS coating transfer process was used to apply such a FTO high temperature coating to PET substrates (Fig. 5).

Transmission of a FTO-PET foil compared to an uncoated foil.

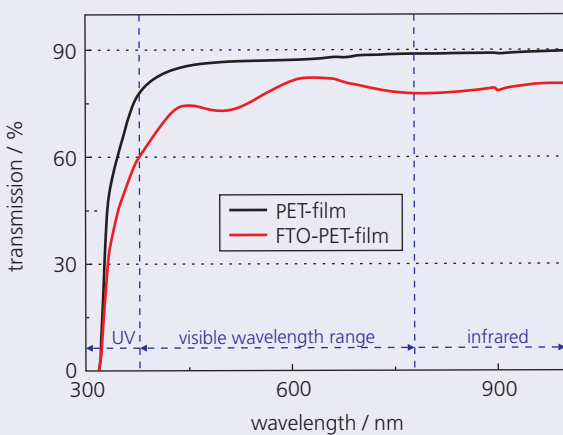

4

SEM image of a FTO-PET foil



5

FTO coated PET foils were produced with a sheet resistance of < 200 Ohm at 75 % transmission (Fig. 4). These properties are sufficient for electro-optical applications. The material combination presents an inexpensive alternative to established indium based (ITO-PET) solutions.

This process in principle combines inorganic material properties with various polymer foils, especially:

- optical properties (IR, UV absorption, color, luminescence)
- electrical properties (semiconductors, conductors, insulators)
- wetting (hydrophobic, hydrophilic)
- barrier function (protection from oxidation and chemicals)

- 1 Electro luminescence foil with transparent front electrode
- 3 Transparent FTO-PET foil

CONTACT

Dipl.-Ing. Thomas Abendroth
 phone +49 351 83391-3294
 thomas.abendroth@iws.fraunhofer.de



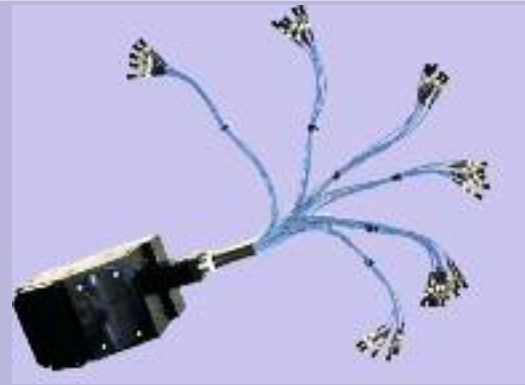

IMAGING SPECTROSCOPY IN NEW DIMENSIONS

THE TASK

Modern automated production continuously requires improved means of process control. Often a 100 % control is desired. Conventional inspection is based on gray scale or color camera monitoring. However, these imaging methods prove to be insufficient for some materials or products. In such cases a spectrally resolving camera solution may offer an alternative. This technology records spatially resolved individual wavelengths of the electromagnetic spectrum. Material specific information such as fluorescence in the visible range can be derived. Chemical information can be obtained when using such techniques in the near infrared range. The term "Hyperspectral Imaging" (HSI) combines all versions of this technology that are applied in various spectral ranges.

Recording spatially resolved spectral information is only the first step. Furthermore the evaluation requires the appropriate adaptation of analysis methods to extract and process information directly from the data stream. Processing speed is extremely critical for real-time process control. IWS engineers developed various approaches to implement successful hyperspectral measurements.

OUR SOLUTION

The hyperspectral analysis systems implemented at the Fraunhofer IWS in Dresden work in the spectral ranges from 400 to 1000 nm and from 1000 to 2500 nm. The field of vision and the size of the analysis objects are nearly unlimited due to the flexible use of optical components. A special diffuser setup made from optical PTFE makes it possible to also reliably analyze highly reflective substrates.

The research focused on software development. A tool was developed that combines numerous individual routines to simplify HSI system configuration, data acquisition and data analysis. Additional libraries can be linked for chemical and statistical interpretation based on many known methods (regression analysis, multivariate methods). The code was implemented close to, and optimized for, the computer hardware architecture to achieve efficient processing performance.

RESULTS

The IWS offers a one-stop solution to apply hyperspectral imaging to processes. This includes consulting and feasibility studies as well as the adaptation of HSI systems to the given processes and the development of appropriate analysis and real-time control solutions. All steps can be performed on site.

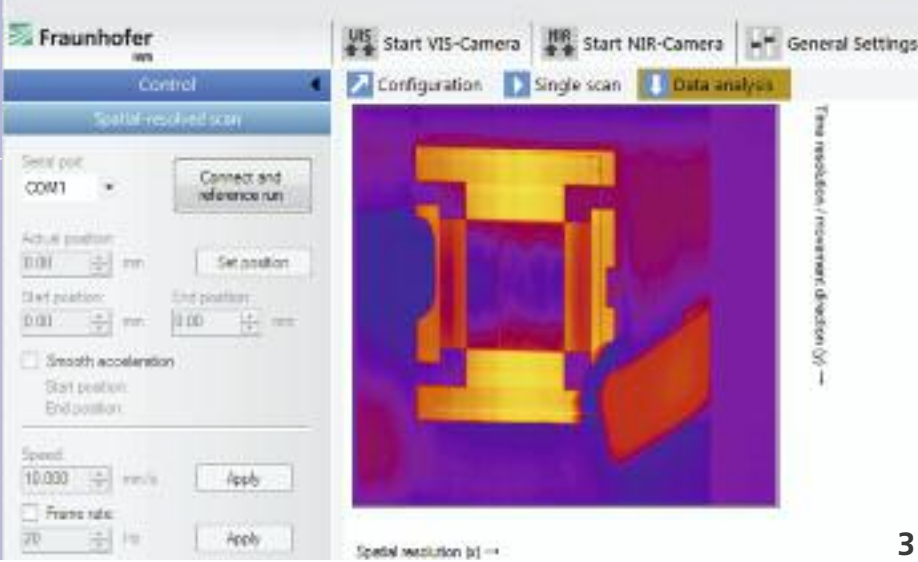

3



Hyperspectral imaging can record images of up to 200 Hz. This is ideal for inspecting surfaces and their condition. Optimized mathematical routines are guaranteed up to 30 times faster than commercially available standard systems and also require substantially reduced computation. All data processing occurs in real-time while maintaining the recording frequency.

Using the technique in the near infrared range makes hidden features visible, which significantly extends the capability of optical inspection methods. The method is suitable to detect defects in transparent surfaces such as thin conductive coatings. Damaged batches can be identified and removed from the production flow prior to final assembly.

A glass substrate coated with fluorine doped tin oxide (left) and visualization in the near infrared range (right) at 1727 nm

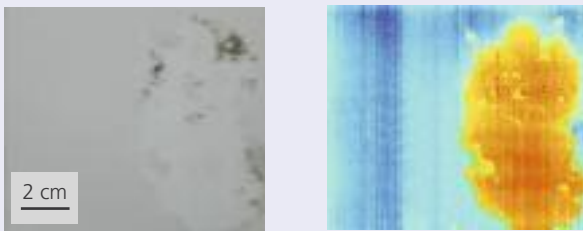

Visualization and clear chemical statistical identification (right) of a grease contaminated steel substrate (left)

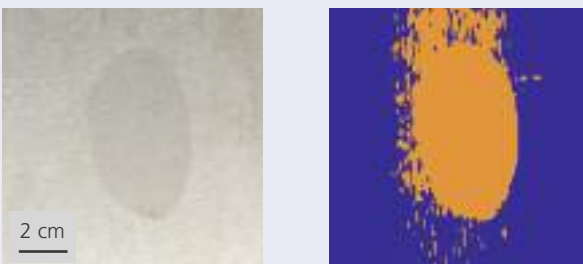

4

The inspection of incoming products is also an important HSI application. The technique can, for example, inspect steel substrates. Automated decisions are possible when the data are analyzed with multivariate techniques (here shown as a cluster analysis).

Another application is the sorting during polymer recycling. It is now also possible to separate black polymers if chemical statistical models are used. Fraunhofer IWS engineers furthered the development in this area in collaboration with the TU Dresden and other partners.

- 1 *Hyperspectral imaging system for the visible range*
- 2 *Fiber coupling of a hyperspectral imaging system*
- 3 *Software example*

HSI technology is suitable for tasks inspecting incoming goods, for quality control and also for direct process control. Applications include the automated detection of sorting processes, the monitoring of coating deposition and the detection of contaminations, defects or foreign materials. A particular strength of the method is the analysis of material properties, which cannot be observed in the visible range.

CONTACT

Dr. Philipp Wollmann
 phone +49 351 83391-3316
 philipp.wollmann@iws.fraunhofer.de





FAST CHARACTERIZATION OF POROUS MATERIALS BY OPTICAL CALORIMETRY

THE TASK

Nitrogen physisorption at low temperatures (77 K) is used to characterize porous materials. Such measurements yield adsorption isotherms and provide detailed information about the samples such as their pore structures and it is possible to calculate the total inner surface area (BET surface). These measurements however require a long time due to the measurement principle, which makes them difficult to use for large sample counts and time critical evaluation.

OUR SOLUTION

Fraunhofer IWS engineers developed an "optical calorimetry" method for fast characterization of porous materials.

The sample is exposed to the test gas. When the gas molecules adsorb to the surface of the sample, adsorption heat is released. This heat in turn increases the temperature of the sample, which is measured with an optical temperature sensor (Fig. 2).

Measurement principle for the quick test method

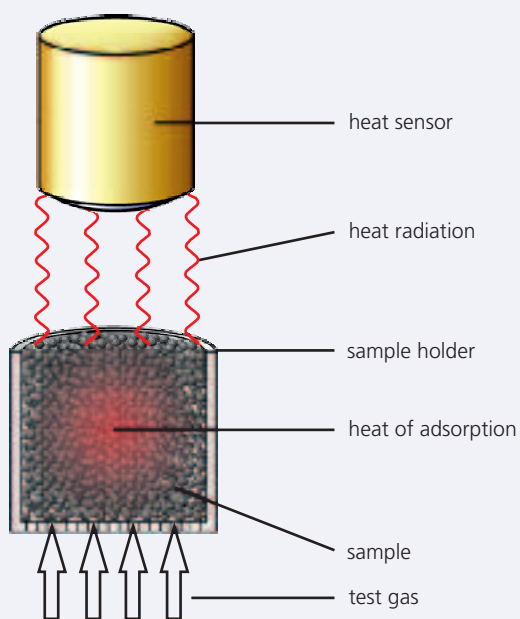

2

The time dependent temperature profile is unique for each sample and so it is possible to derive information about the adsorbed gas quantity and about the kinetics of the adsorption process. The time to perform such a measurement is usually a matter of a few minutes.

RESULTS

This characterization method and the experimental setup has been further developed. It is now possible to approximate adsorption isotherms in a short time. The conventional screening method requires the test gas to flow through the sample. The new method operates similar to the volumetric method. The sample is placed in vacuum and the test gas is added step by step until the desired target pressure is reached. The temperature change is recorded during each step (Fig. 3).

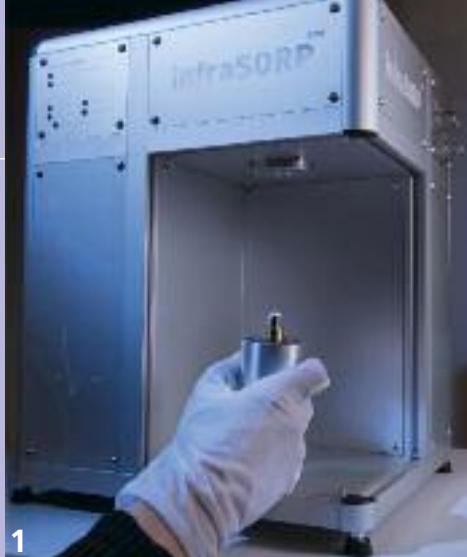

1

The temperature signal is continuously recorded and its integral plotted versus the equilibrium pressure reached at the end of each step. This method is sufficiently accurate to determine the shape of the adsorption isotherm. Fig. 3 compares two adsorption isotherms of an activated carbon sample up to 2 bar absolute pressure. One isotherm was volumetrically measured at 25 °C using CO₂ and the other one was obtained using the described quick testing method. Both measurements overlap after a simple scaling procedure.

Thus the quick testing method is capable of accurately measuring the sample properties in a short period of time, which is in particular important for larger sample batches and for time critical applications.

Similar to the through flow method the quick test is not limited to particular gas types. A principle condition however is that the sample is sufficiently heated by the adsorption process so that the temperature increase can be detected.

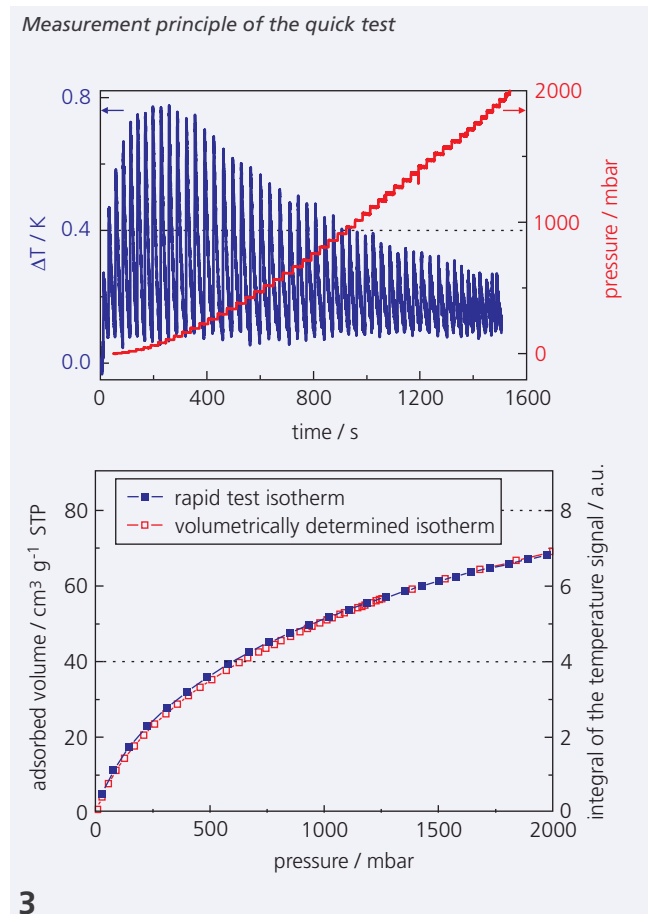

3

1 Measurement device for static experiments to approximate the adsorption isotherm

CONTACT

Dr. Matthias Leistner
 phone +49 351 83391-3421
 matthias.leistner@iws.fraunhofer.de





1

PLASMA SOURCE FOR LARGE AREA SURFACE CONDITIONING

THE TASK

Plasma surface conditioning at atmospheric pressure has applications in many areas that require surface treatment to prepare them, for example for adhesive bonding processes. Applications include the functionalization of surfaces of composite materials to improve the adhesion of additional layers such as the deposition of adhesion promoters for structural bonding processes.

An example is the deposition of adhesion promoters onto curved surfaces of TiAl6V4 alloys as used in the aerospace industry. The process requires a working range of ± 40 mm. It is essential to achieve very high bonding strengths to ensure long-term stability of the nanostructured and adhesively bonded joints under tough environmental conditions including varying humidity and temperature ranges.

Similar applications occur in the steel industry where adhesion promoters need to be applied to highly efficient mass products of lightweight designs such as preformed parts for making honeycomb structures. The challenge is treating large areas at low costs.

The task was to develop plasma surface treatment processes that can be established on an industrial scale. Primary objectives for the plasma source aimed at scalability, flexibility and operation with minimal consumables at low cost.

OUR SOLUTION

Fraunhofer IWS engineers developed the large area plasma source LARGE (Long-Arc-Generator) for such surface

conditioning applications. This plasma source operates an arc discharge, which can be scaled in length up to 350 mm. Free radicals and atomic species are generated from a gas flow passing this arc discharge. These activated species are driven out of the plasma source toward the treatable surface. Types and concentrations of activated species depend on the process gas composition and flow rates.

A special feature of the LARGE plasma source is its suitability for a wide range of plasma gases and their mixtures such as compressed air, Ar + O₂, N₂, CO₂, H₂, NH₃ etc. The process gas is carefully composed to target the plasma species especially to the requirements of the treatable surface. Additional precursor gases can be fed (Fig. 1) to the plasma outside of the plasma source. This way it is possible to use the LARGE plasma source for the reactive deposition of adhesion promoters. Other applications are chemical etching, functionalization and surface cleaning.

LARGE is compact and easily mounted to a robot arm, which makes it movable. The source is also easily deployed in an inline process since it does not require vacuum locks. One source can handle a sheet width of up to 350 mm. Larger dimensions are treatable by combining several sources.

RESULTS

The LARGE plasma source generates a long and very intense plasma sheet (Fig. 2). Flare lengths can be up to 90 mm when using compressed air.

Thus 3D parts can be efficiently treated in very fast processes.

2

In order to deposit an adhesion promoter layer such as SiO_2 the LARGE plasma source is operated with an additional reactive process gas feeding system (Fig. 1). The substrate can be as far as 40 mm away from the plasma source. Nanostructured SiO_2 films are deposited at atmospheric pressure. The precursor gas defines the chemical composition of the film. Using HMDSO¹ for example yields carbon containing SiO_2 coatings with hydrophobic properties. When using TEOS² on the other hand, the CH_3 groups will completely dissociate. Thus the resulting SiO_2 films are carbon free. Due to OH groups they are hydrophilic. The morphology can also be engineered from rough for better mechanical anchoring of the adhesive to smooth and dense to achieve diffusion barrier functions (Fig. 3).

SEM image of nanostructured SiO_2 coatings on TiAl6V4 for structural bonding (left) and as a barrier coating (right)

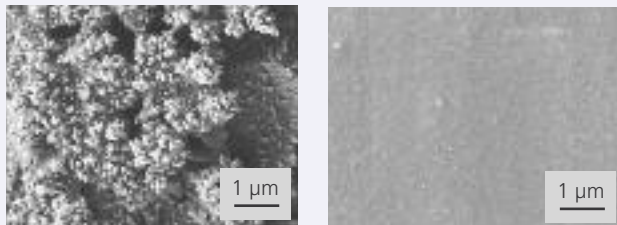

3

The joint areas of preformed stainless steel sheets for honeycomb lightweight structures were coated with SiO_2 films at thicknesses from 100 to 200 nm. Such surfaces were tested using a single axis ripping test (based on DIN EN ISO 4624). The measured ripping strengths for the metal-epoxy system exceeded 16 MPa, which is an excellent adhesion. Untreated surfaces failed at 5 MPa.

¹ hexamethyldisiloxane

² tetraethoxysilane

³ alkaline etching with Turco 5578 at 95 °C for 5 min

⁴ NaTESi pretreatment method

Another example from the aerospace industry is the structural joining of TiAl6V4 that was pretreated in corrosive fluid³. The mechanical strength and the long-term stability of the adhesive bond were evaluated using the wedge test (DIN 65448). The results showed that a 50 nm SiO_2 layer helps to improve the adhesive strength over the currently used standard process NaTESi⁴ (Fig. 4).

Result of the wedge test according to DIN 65448, the crack propagation is plotted versus time on pretreated TiAl6V4

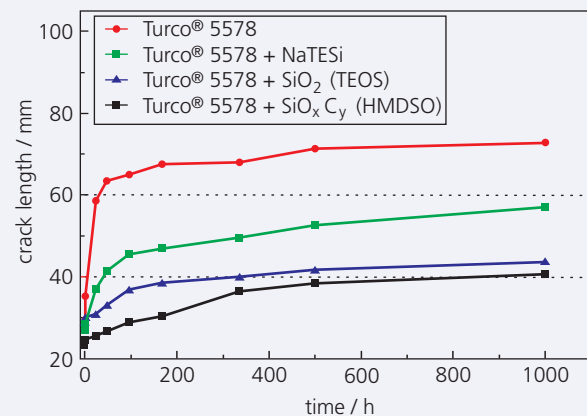

4

- 1 150 mm LARGE plasma source with boron nitride flange for coating deposition
- 2 150 mm LARGE plasma source running a Ar-N₂ plasma without flange

CONTACT

Dipl.-Ing. Liliana Kotte
 phone +49 351 83391-3439
 liliana.kotte@iws.fraunhofer.de



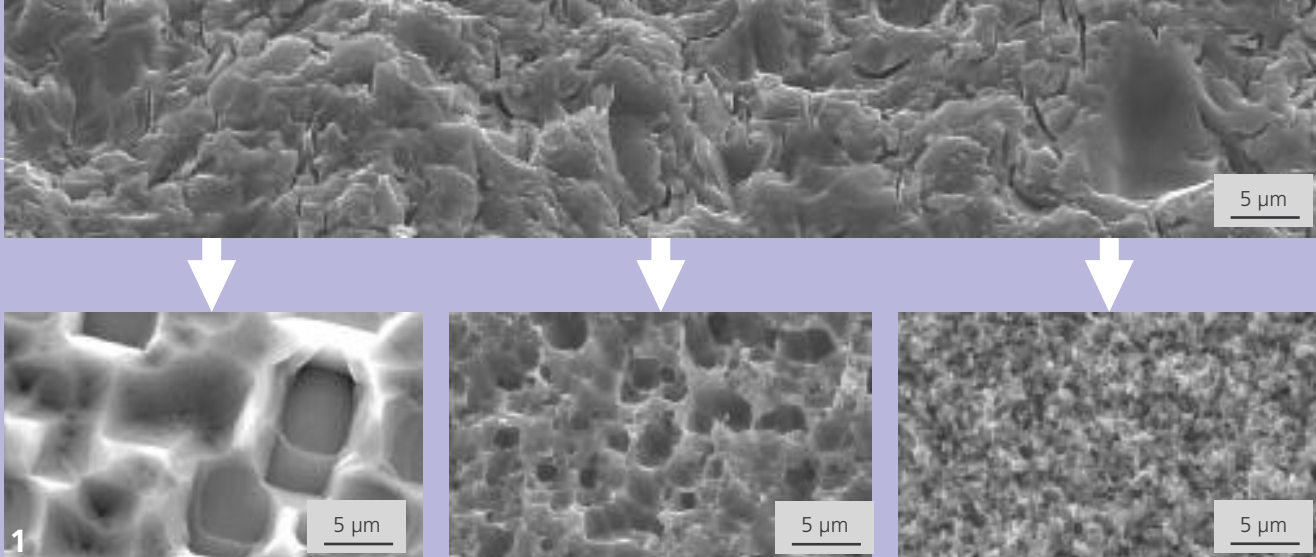

FROM MICRO TO NANO: CONTROLLED SURFACE STRUCTURING OF SILICON SOLAR WAFERS

THE TASK

The manufacturing process of crystalline Si solar cells includes several etching steps to remove saw damage, to texture the surface and to insulate the wafer edges. As an alternative to costly wet chemical etching steps Fraunhofer IWS engineers developed a plasma etching process using fluorine (F_2) gas and operating at atmospheric pressure (AP).

The task was to further develop the processing system so that wafers can be handled of up to 6" in various geometries. The system should be capable to treat the wafers single- or double-sided. Process development focused on saw damage removal, surface smoothening and texturing with a particular aim at expanding the shape and aspect ratios of etched structures

OUR SOLUTION

Long-term stable process monitoring and control is not only essential to optimize the system technology but also to operate the plasma etch technology under industrial conditions. Consistent process monitoring yielded information that was important to better characterize and understand the etching processes. Only then was it possible to reproduce different textures as a function of process parameters.

This knowledge enabled the development of a modular etching reactor, which can be adapted to generate different surface structures. The combination of etching gas input and

process parameter variations made it possible to reproducibly structure silicon surfaces with structures ranging from micro to nanometers in size.

A very promising inline process monitoring technique is FTIR spectroscopy. The non-contact and non-destructive method provides time resolved quantitative information about the silicon tetrafluoride (SiF_4) concentrations, which is the primary etching byproduct. The process monitoring occurs in the exhaust gas flow (Fig. 1). Spectra are measured in real-time and analyzed by software to plot the gas flow versus time (Fig. 3).

Integrating this curve yields the total amount of SiF_4 from which all quantities of interest are being calculated.

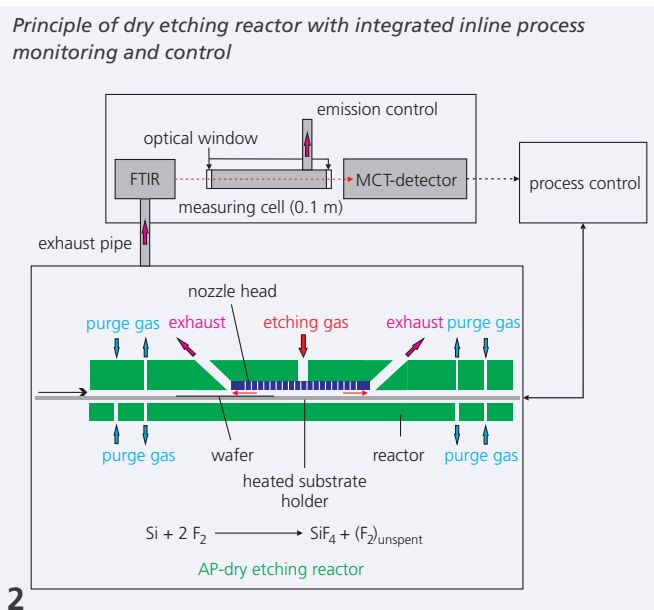

RESULTS

Quantitative FTIR measurements of SiF_4 absorption bands were employed to characterize different etching process with respect to etching depth and rate. These spectroscopically determined results correlate very well with offline data obtained from conventional gravimetric measurements. The FTIR data also confirm the reproducibility of the processes.

These results helped to iteratively redesign the reactor nozzle head through which the etching gas reaches the substrate. The optimized reactor is now capable of generating micro and nanoscale textures by design with different depths and densities on silicon surfaces. Depending on the desired results process parameters are adjusted including the hardware configuration, total gas flows (5 – 60 slm), F_2 concentration (0.08 – 10 %) and substrate temperatures (150 – 400 °C).

This technology is useful in solar wafer manufacturing for the following steps:

- surface texturing of saw damage etched wafers
- combination of saw damage etching and surface texturing
- backside smoothing

The available texture palette was expanded with respect to the aspect ratios of the etched structures, which makes the technology also interesting for applications outside of photovoltaics.

This research was funded through the EU project SOLNOWAT (286658).

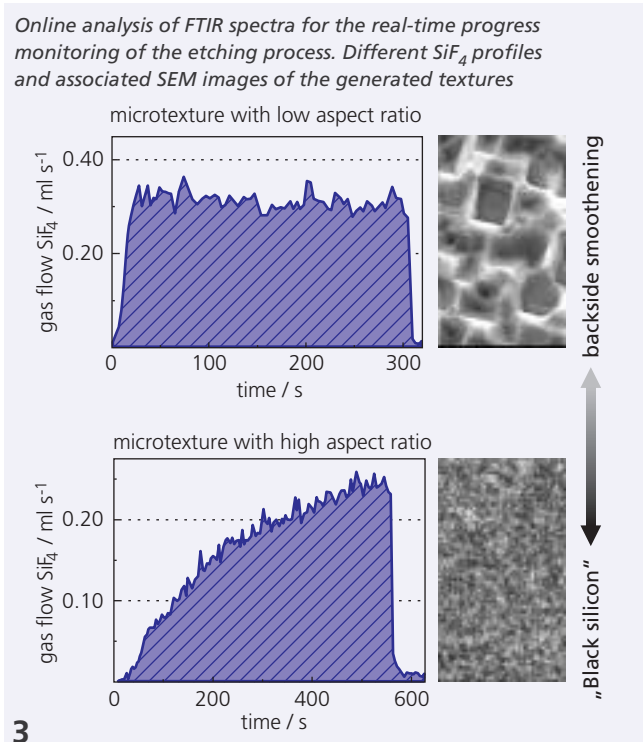

- 1 SEM images of Si wafer surfaces, top: unetched (as cut), bottom: various textures generated through F_2 etching

CONTACT

Dr. Gerrit Mäder
 phone +49 351 83391-3262
 gerit.maeder@iws.fraunhofer.de



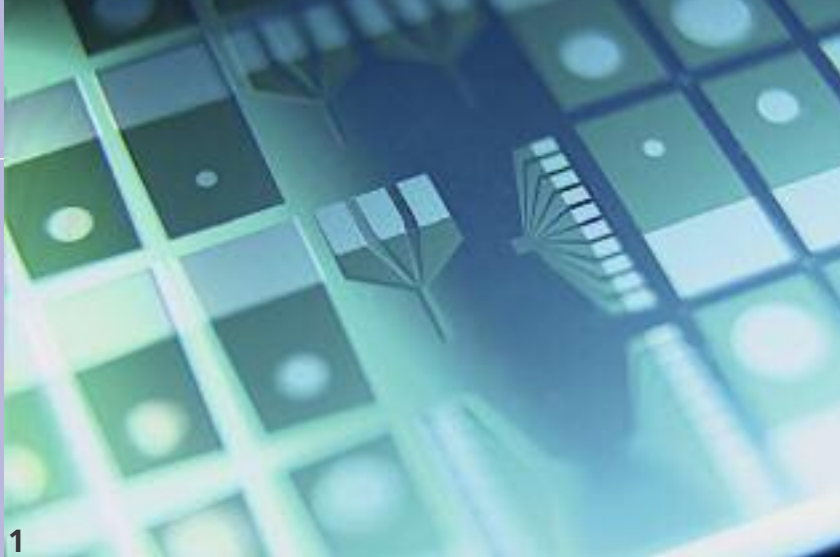

1

BORON DOPED DIAMOND COATINGS FOR ELECTROCHEMICAL APPLICATIONS

THE TASK

Since the late 1980s researchers have been aware of the excellent properties of boron doped diamond (BDD) as an electrode material for electrochemical applications. These properties include the largest electrochemical potential window, the low charge carrier double layer capacitance, the low and featureless background currents, the low adsorption and an excellent resistance to corrosion even in aggressive media. With these properties BDD is a multivalent electrode material useful for numerous applications in electrochemical analysis, water treatment or chemical synthesis.

In particular the large potential window in combination with the low background currents and low adsorption make BDD electrodes particularly interesting for electrochemical trace analysis and neurochemistry. For trace analysis and neurochemistry microelectrodes and microelectrode arrays (MEA) are the preferred design. The beneficial characteristics of microelectrodes and MEA are based on the radial diffusion toward the electrode surface versus the planar diffusion in macro electrodes. Radial diffusion results in enhanced mass transport, higher current densities and lower background currents.

BDD microelectrodes and MEA are superior compared to state-of-the-art solutions in terms of their detection limits. Such electrodes can be designed to provide spatially resolved data including multi element analyses.

OUR SOLUTION

Researchers at the Fraunhofer CCL developed a microfabrication process to manufacture BDD microelectrodes and MEA. An especially tailored solution is offered for each application.

The basic diamond material is deposited by microwave plasma CVD. This process is suitable for the fabrication of a range of diamond materials from ultra nanocrystalline diamond to single crystalline diamond of optical quality. The diamond can also be doped to utilize its excellent semiconductor properties. The boron doped variation BDD is the focus of current research activities. BDD films can be deposited onto many different substrate materials including silicon, quartz and metals.

The fabrication of MEA requires smoother substrate surfaces. Therefore MEA are produced on silicon and quartz wafers. Established microfabrication processes from the semiconductor manufacturing industry can also be used to structure BDD. These include photolithographic structuring, wet chemical etching, plasma etching, metallization and insulation. The final step is laser cutting, which separates the wafers into individual chips.

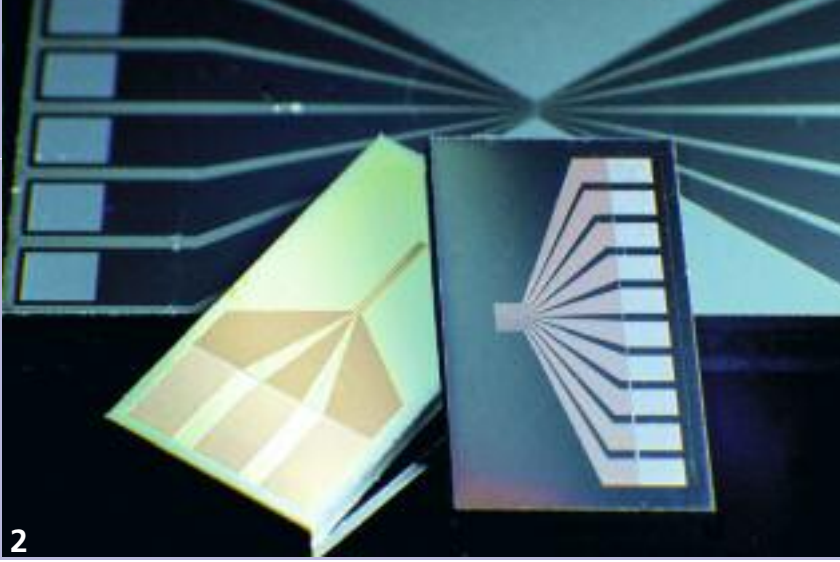

RESULTS

The use of established microelectronic manufacturing steps is critical to manufacture customized boron doped diamond MEA at reasonable costs. Fig. 1 shows a wafer, which contains several chip designs including MEA and macro electrodes.

The MEA structures shown in Fig. 2 enable the simultaneous measurement of different species with 3 to 12 independent microelectrodes. Alternatively the same specie can be measured with spatial resolution on a very small scale. This design for example can be used to study the electrochemical response of a single neuron.

Fig. 3 shows the cyclic voltammogram for a BDD MEA with preferred radial diffusion compared to a macro electrode with primarily radial diffusion. Both electrodes show the expected curves and equilibrium states. The established microfabrication processes ensure the reproducibility of the MEA manufacturing process.

The Fraunhofer CCL also produces larger area electrodes of up to 150 mm in diameter as well as macro electrodes of up to 4 mm in diameter all, of them being used for electrochemical applications. Other developments include optically transparent electrodes, and freestanding and framed BDD foils and windows.

Cyclic voltammograms of a MEA (1 mM $K_4Fe(CN)_6$ in 0.1 M KCl, top) and of a macro electrode (1 mM $K_4Fe(CN)_6$ in 1 M KCl, bottom)

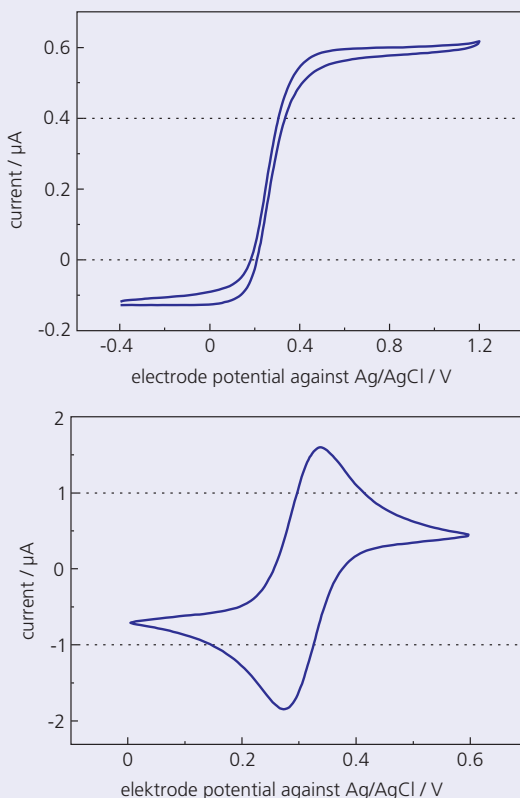

- 1 Microelectrode arrays (MEA) fabricated on silicon wafers
- 2 Individual laser cut MEA chips

CONTACT

Dr. Thomas Schülke
 phone +1 517 432 8173
 tschuelke@fraunhofer.org



HEAD OF DEPARTMENT PROF. DR. ANDREAS LESON



"If you want to have good ideas you must have many ideas. Most of them will be wrong; what you have to learn is which ones to throw away."

Linus Pauling



BUSINESS FIELD PVD VACUUM COATING TECHNOLOGY

Editor: One of the core competences at IWS is the deposition of extremely precise multilayer coatings, which are, for example, key components in X-ray optics and also in EUV lithography applications. What happened last year in this field?

Prof. Leson: The EUV lithography is currently at the threshold of being introduced to the market. First production tools were installed for high volume manufacturing. The technical requirements are increasing with the advancing development of this technology. We are working on new solutions to address these demands. Furthermore, we are applying our know-how to other applications. For example, currently we are working very intensively on the development of novel X-ray lenses with highest resolution. In the future we expect applications in non-destructive testing of materials down to the nanometer range. The results so far are very promising.

Editor: The group working on carbon coatings is again enjoying a strong demand in R&D services. What were last year's developments?

Prof. Leson: For quite some time we have been working with car manufacturers to exploit the potential of carbon coatings to reduce friction. Reducing CO₂ emissions and fuel consumption is of great importance to society. We are focusing especially on ta-C coatings, which offer enormous advantages in this field. During 2013 we were able to address many principle questions and we successfully finished a BMWi funded project. We are also very excited that the BMWi supports the continuation of this project, which now aims at transferring the results to real powertrain components.

Editor: PVD coatings are typically a few micrometers thick. However, most interestingly, your department also works on making thicker coatings of up to 100 micrometers using thin film deposition techniques. Are there applications for such coatings?

Prof. Leson: In recent years we have been able to develop coatings that are substantially thicker than typical PVD films. Tailored process development has enabled the control of intrinsic stresses and defects. Deposition rates were substantially increased to economically deposit these coatings. Such coatings indeed have a number of very interesting applications. Examples include an increase of the tool life for cutting inserts and deep drawing dies. It is also possible to fine-tune the tool geometry post deposition, which is very relevant for making precision tools. I am convinced that we will apply these coatings in many new applications during the coming years.



COMPETENCES

X-RAY AND EUV OPTICS

Individual and multilayer nanometer coatings for EUV and X-ray optics are deposited using magnetron and ion beam sputter deposition as well as pulsed laser deposition techniques. The deposited coating systems meet the highest specification requirements with respect to film thickness accuracy, roughness, chemical purity, lateral homogeneity and reproducibility. Such coatings are used in X-ray optics and X-ray optical systems but also as reactive multilayers for precision joining of materials. Additional capabilities include the characterization and modeling of nanometer coatings.

CARBON COATINGS

This group developed superhard ta-C carbon coatings (Diamor®), which are excellent protective coatings reducing friction in lubricated and non-lubricated application conditions. The coatings are deposited on various tools and components and with a wide range of possible thicknesses. The associated deposition process is the Laser-Arc™ technology, which was especially developed to produce ta-C coatings. Fraunhofer IWS engineers work on deploying Diamor® coatings in the market place. IWS and partners also offer the coating plasma sources and machines as well as the laser acoustic analysis technique LAwave® for quality control and coating optimization.

PVD COATINGS

Physical vapor deposition (PVD) techniques enable the deposition of high value added tribological and functional coatings covering a thickness range from a few nanometers to some hundreds of micrometers. The group has PVD processes at its disposal, e.g. high rate evaporation and highly activated plasma processes and their combinations. A special focus is the application of arc discharges, which most efficiently produce energetic vapor jets. Very thick PVD coatings are offered as well, which are suitable for many applications.



**HEAD OF DEPARTMENT
PROF. ANDREAS LESON**

phone +49 351 83391-3317
andreas.leson@iws.fraunhofer.de



**GROUP LEADER
X-RAY AND EUV OPTICS**

DR. STEFAN BRAUN
phone +49 351 83391-3432
stefan.braun@iws.fraunhofer.de



**GROUP LEADER
CARBON COATINGS**

DR. VOLKER WEIHNACHT
phone +49 351 83391-3247
volker.weihnacht@iws.fraunhofer.de



**GROUP LEADER
PVD COATINGS**

DR. OTMAR ZIMMER
phone +49 351 83391-3257
otmar.zimmer@iws.fraunhofer.de



2013 PROJECT EXAMPLES

- | | |
|---|----|
| 1. Industrial deposition of thick carbon coatings on piston rings | 44 |
| 2. From the idea to the product:
Carbon coatings are making the cut | 46 |
| 3. New coating solutions for massive forming tools | 48 |
| 4. Multilayer Laue lenses for highest resolution X-ray optics | 50 |
| 5. Laser acoustic testing machine for the surface analysis of silicon blocks and solar wafers | 52 |



INDUSTRIAL DEPOSITION OF THICK CARBON COATINGS ON PISTON RINGS

THE TASK

An important part of friction losses in engines originates at the contact surfaces between piston rings and cylinder walls. The piston ring package consists of piston, rings and cylinder sleeve and is of special importance among motor components. Up to 4 % of the total fuel consumption can be attributed to the friction performance of the piston ring package. This fuel and the associated CO₂ emissions can be saved with a friction reducing coating on the piston rings, that can be applied on an industrial scale. What is needed are wear and temperature resistant long lasting coatings with thicknesses exceeding 10 µm.

OUR SOLUTION

Since years Fraunhofer IWS engineers have been working on many applications for tetrahedrally bonded amorphous carbon coatings (ta-C), which are deposited using a laser controlled vacuum arc process (Laser-Arc technology). This ta-C coating type, as opposed to amorphous hydrogenated carbon coatings (a-C:H), can be deposited with almost any thickness, as long as the adherence to the substrate is sufficient. An especially developed adherence layer technology is enabling ta-C coatings of more than 20 µm thicknesses, which makes them especially applicable to piston rings (Fig. 1).

Initially the transition of the ta-C technology from the laboratory to industrial use began with the Laser-Arc-Module LAM 400 in combination with a standard PVD coating machine. In a first step the technology was adapted to coat two piston ring materials, nitride steel and cast iron. The deposition of well-adhering 20 µm thick ta-C coatings was successfully demonstrated on both materials. The second step was then the implementation of the same technology using the LAM 500 coating module, which has a substantially higher deposition rate and a larger deposition height of 500 mm.

Work on optimizing surface smoothness has been another focus in addition to developing the deposition process. The arc process typical deposition of droplets and particles increases the as-deposited coating roughness and necessitates post treatment. IWS engineers developed and patented a brushing process, which was adapted to the outer contour of the piston ring surface.

SEM cross-section image of a ta-C coating on a steel piston ring





RESULTS

The deposition rate which can be achieved by PVD arc processes is limited by the average arc current at the plasma source. The Laser-Arc technology is a pulsed arc process. Here the pulse frequency, pulse peak current and pulse duration are the parameters defining the average arc current. These parameters were all increased when scaling the process from the LAM 400 to LAM 500 module.

The LAM 500 with its powerful current parameters (1600 A pulse peak current, 0.33 ms pulse duration, 200 A average current) achieves a deposition rate exceeding $2 \mu\text{m h}^{-1}$. These rates were measured for a fully loaded chamber with 8 rotational axes and two-fold rotating parts. Initially tubular parts were tested. Subsequently some of the tubular parts were loaded with piston rings (see Fig. 3). Coating a full batch of piston rings with $20 \mu\text{m}$ of ta-C requires a deposition time of 10 hours.

Coating uniformity and sufficient deposition rates were successfully demonstrated developed at the IWS Dresden. Tests then followed to evaluate the long-term stability of the deposition process with the LAM 500 module. More than 10 full coating runs were performed and verified the reproducibility of the coating properties and in particular of the hardness, which did not change.

The post deposition brushing of the ta-C coatings was performed with a special process. The achievable surface roughness was $R_z < 0.6 \mu\text{m}$ and $R_{pk} < 0.06 \mu\text{m}$ (Fig. 4). The brushing process was further optimized and it was demonstrated that the process could be automated.

The ta-C coated and brushed piston rings were then evaluated in firing motor tests at the customer. The rings were exposed to 240 h of engine testing and afterwards the coatings were analyzed for mechanical and structural properties. Hardly any wear was found and no signs of damage could be determined. The coatings performed far superior compared to all other known coatings with respect to friction performance, wear and scorch mark resistance.

These excellent performance results in combination with the capability of producing the coatings in industrial quantities led to the direct launch of production. Meanwhile a complete ta-C coating machine was installed at a customer site. The machine is a DREVA 600 PVD coater with integrated LAM 500 module (Fig. 2). The successful startup of this machine marks the start of series production of ta-C coated piston rings in 2014.

- 2 *PVD coating machine with LAM 500 installed at a customer site*
- 3 *Piston rings and test parts with a $20 \mu\text{m}$ thick ta-C coating*
- 4 *ta-C coated piston rings after mechanical smoothing*

CONTACT

Dr. Volker Weihnacht
 phone +49 351 83391-3247
 volker.weihnacht@iws.fraunhofer.de



FROM THE IDEA TO THE PRODUCT: CARBON COATINGS ARE MAKING THE CUT

THE TASK

Knives dull whereas rodent's teeth do not. Their dentition is highly specialized for gnawing with an elastic dentin and much harder enamel. Gnawing mainly wears out the dentin whereas the enamel remains as the hard cutting edge.

IWS engineers made use of this principle to develop a technical solution for kitchen knives (see schematics in Fig. 1). The blades are coated on one side only with tetrahedrally bonded amorphous carbon (ta-C) coatings. A high current pulsed arc technology is used to deposit very hard films with extreme adhesion to the substrate. The deposition process does not expose the blade steel to high temperatures so that no loss in hardness occurs.

Cut performance tests were performed according to DIN EN ISO 8442. The results document that the coated blades maintain their sharpness and hold their edge quality for much longer than uncoated knives, which is attributed to the described self-sharpening effect.

In collaboration with an industrial partner, the next step is to translate this technical concept into a marketable product. The following tasks have to be accomplished:

- economical cost structure
- appealing product design
- incorporating the coating step into the manufacturing process of the knives
- high product quality in-series manufacturing

OUR SOLUTION

In a first step the deposition process was optimized for maximum coating adherence and cutting edge stability, while simultaneously minimizing the processing time. The cutting performance and edge stability were frequently measured to optimize the process.

An appealing product design was developed based on customer input. Only a 10 mm wide strip is being coated along the blade edge. The existing fixtures were modified so that not to be coated blade surface areas could be masked. Simultaneously the fixture has to be easy to use and also allow for a maximum coating batch size. In addition all common means of ensuring the quality in mass production were implemented. Parameters were identified that are critical to product quality. They were optimized and monitored for quality assurance.

The next step was to define the interfaces between the

Schematic comparison of a single side coated knife blade with the design of a rodent tooth

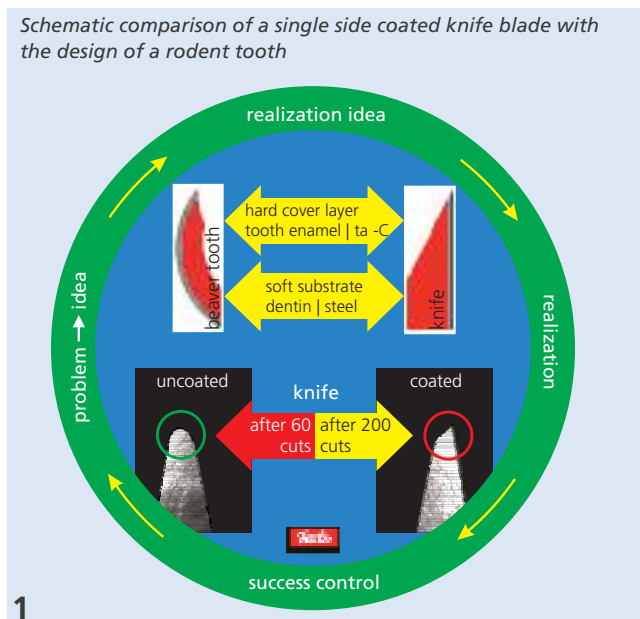

1



2



3

different processing steps in the manufacturing chain (forging, grinding, coating, molding of the handle, hemming, fine sharpening). The product tolerances and communication paths were defined as well as means to reduce costs.

RESULTS

Several batches were coated in conditions close to the manufacturing environment to improve processes and product quality. The optimized fixtures turned out to be simple and easy to handle. They also sharply mask the uncoated from coated areas. The design was optimized to increase the batch size to 132 blades (Fig. 2).

The individual processing steps were timed and analyzed for savings potential. The optimization resulted in 8 % overall cost reduction. Such optimized processing steps were documented in the form of work instructions.

The coating process step was successfully incorporated between pre- and post processing steps and quick communication paths were established, successfully avoiding production delays. Product errors were quickly identified, evaluated and associated with a particular manufacturing step. Corrective actions were derived to remove the root cause of these errors. The number of errors and affected knives (scrap) was minimized.

Final cut performance tests yielded a threefold improvement compared to the standard for non-resharpenable knives. This result is also substantially exceeding the edge performance of ceramic knives. Two knife products with aesthetic designs are now successfully marketed and sold.

The Fraunhofer IWS is grateful to the Research Society for Tools and Materials e.V. (FGW) in Remscheid performing the knife tests.

- 2 *Large chamber PVD coating machine with 132 knives in 33 fixtures*
- 3 *Forged, ground, coated and finished knife (from left to right)*

CONTACT

Dr. Thomas Stucky
 phone +49 231 844-3888
 thomas.stucky@iws.fraunhofer.de





NEW COATING SOLUTIONS FOR MASSIVE FORMING TOOLS

THE TASK

The term "massive forming" designates a group of modern manufacturing processes in metal forming. It is characteristic for such processes that substantial amounts of material are displaced or accumulated during forming, which typically requires substantial mechanical forces. Typical products of massive forming processes are powertrain elements such as toothed shafts, connection rods or screws as well as numerous types of semi-finished products and preforms.

Massive forming tools are exposed to substantial mechanical loads especially in surface near regions. High contact pressures are combined with relative motions, which is challenging for the tool surfaces. Abrasive wear is the limiting factor for tool life. An additional challenge is often the high process temperature.

Such tools are made from highly temperature resistant materials to achieve a long tool life while making quality products. The associated material costs are very high. Surface modifications are sought to further improve the tool longevity by reducing friction and wear under extreme loads. Under ideal circumstances it should also be possible to use less costly bulk tool materials in combination with high performance surface treatments.

A cooperation project was performed to investigate the possibilities to reduce wear and friction in forming processes.

OUR SOLUTION

The project work performed at the Fraunhofer IWS Dresden focused on development and testing of suitable high temperature resistant coatings. The following requirements were defined:

- high hardness and abrasion resistance under high contact pressures
- low friction versus steel surfaces in lubricated tribosystem
- avoidance of cold welding
- avoidance of crack formation and provision of excellent coating adhesion to substrate

Experiments were performed to identify and characterize suitable coating systems. The applied coating process was an industrial arc technology, which is a standard technology for the coating of tools.

The tribological behavior of the coated surfaces was tested in a tribometer with ball-disk setup. The coated test specimen is placed in contact with a steel ball, which moves back and forth across the sample under lubricated conditions with defined contact pressure. Outputs of this experiment are the coefficient of friction and the wear rate.

Additional ring compression experiments were performed to more closely represent application conditions. A steel ring is mounted between two compression plates and then compressed to half of its original height. This represents conditions which are typical for many forming tools that are shaped in the form of round blanks.

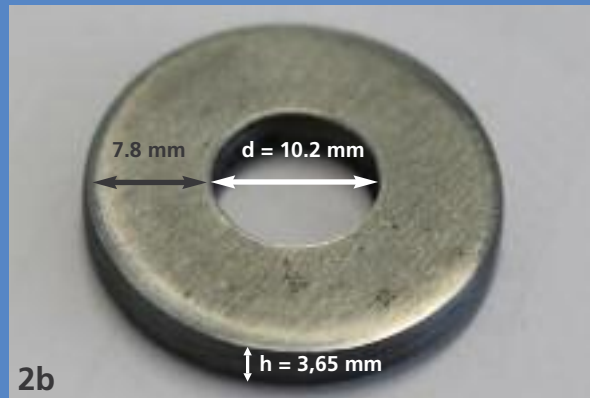
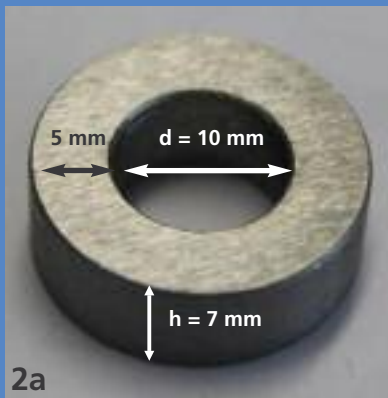

RESULTS

The tribometer tests yielded varying degrees of wear for the different samples. Uncoated steel samples showed substantial wear. On the other hand there was almost no wear detectable on samples coated with AlCrSiN or AlCrTiN. This is in particular impressive since the test was performed with very high contact pressures for the coated samples (> 2000 MPa compared to 1750 MPa for uncoated samples).

Uncoated and coated round steel blanks were used as compression plates for the ring compression tests (Fig. 2). In the case of uncoated blanks the material was the more expensive steel type 1.2379. The coated blanks were made from lower alloyed C45 steel. Fig. 3 shows the development of wear patterns of uncoated and coated round blanks.

Even after 50 compressions there is no wear detectable on coated blanks (bottom right).

These results show the impressive potential of such coatings for forming tools. Wear reduction was demonstrated even on a lower alloyed steel being used as the tool material.

The Fraunhofer IWS is grateful to the Fraunhofer IWU in Chemnitz for performing and analyzing the forming tests.

Uncoated (top row) compression plates and coated compression plates (bottom row)

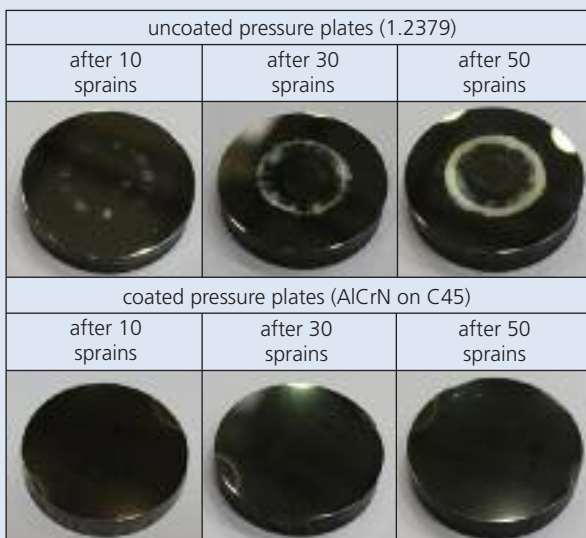

- 1 Coated demonstrator tool (extrusion press stamp)
- 2 Ring for ring compression test, a) prior to compression and b) post compression (photo IWU)

CONTACT

Dr. Otmar Zimmer
 phone +49 351 83391-3257
 otmar.zimmer@iws.fraunhofer.de



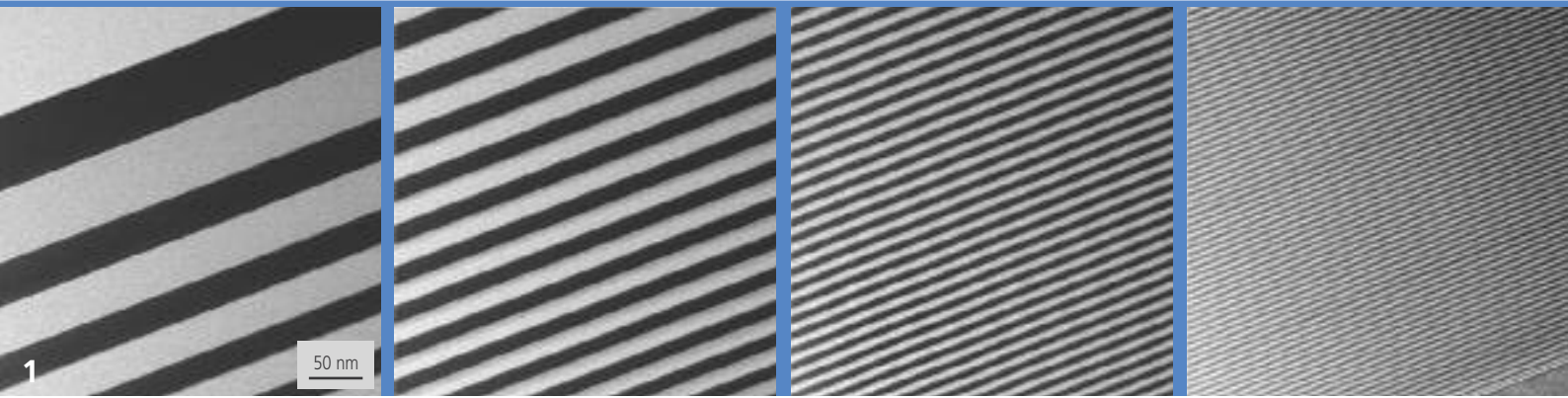

MULTILAYER LAUE LENSES FOR HIGHEST RESOLUTION X-RAY OPTICS

THE TASK

The continuously advancing miniaturization of microprocessors requires constant improvements to the associated analytical techniques. In a suitable setup, X-ray microscopy, for example enables the nondestructive observation of small structures under operating conditions. This can be applied to identify defects and to avoid them in the future. In addition to absorption imaging, using X-ray analysis also yields information about the chemical composition of the studied samples.

The most frequently applied analytical technique is to use full-field imaging of samples in laboratory based X-ray microscopy systems. It is also possible to use the parallel beam of a synchrotron beam source to scan a sample and to generate an image.

The resolution in such experiments is primarily limited by optical components. Zone plates and refractive X-ray lenses offer image resolutions of better than 100 nm. However, meanwhile the typical structure size of interest is smaller than 50 nm. Thus development is required. Zone plate fabrication for hard X-rays of 8 keV and higher is facing principle lithography limitations, which limits efficiency and focus size.

The resolution of X-ray optical components needs to be improved in order to keep pace with current manufacturing technology progress. Ideally this can be achieved without limiting the practical use of the setup.

OUR SOLUTION

Multilayer Laue lenses function based on X-ray diffraction and improve the technical limits of currently used Fresnel zone plates in decisive areas. Resolution and focus are in the range of the thinnest possible coating thickness. Coatings with a thickness of 1 nm represent the so far achieved resolution limit.

The fabrication of such a lens requires the deposition of thousands of coatings with, according to the zone plate law, increasing thicknesses. The total thickness may be as high as 50 μm . The deposition process has to be absolutely stable and the individual film thicknesses must be precise.

Fraunhofer IWS engineers achieved zone widths between 5 nm and more than 300 nm. The process does not make complete, but partial lenses on one side of the optical axis.

Such a coating is then post processed so that a freestanding lamella remains with only a few micrometers in thickness. This is the actual lens, which generates a line focus. Two lenses are glue bonded to make an optical component with a point focus.

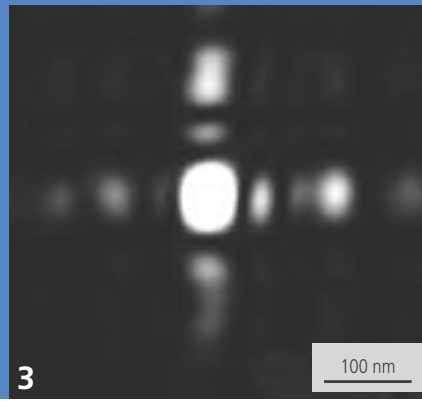
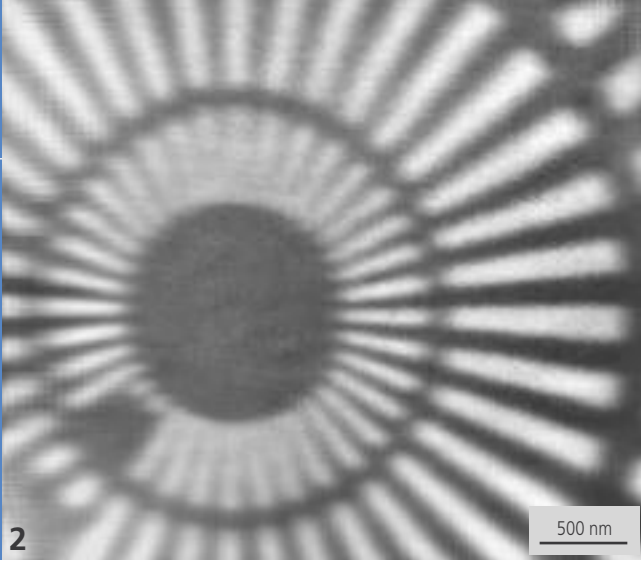

RESULTS

Multilayer Laue lenses were tested at the synchrotron facility in Hamburg, Germany, and at the ESRF in Grenoble, France. First experiments used a multilayer Laue lens in a crossed arrangement with a nanofocus diffractive lens. The diffraction image was interpreted using ptychographic reconstruction methods. In addition to structural information it was also possible to extract the complex wave field of the optics, the shape of the focus and the caustic (Fig. 2).

The next experiments were performed with two multilayer Laue lenses in a crossed arrangement. This setup was used to study integrated circuits and samples for nanostress analysis. The two crossed multilayer Laue lenses achieved a point focus of $39 \times 49 \text{ nm}^2$ (Fig. 3) at 20 keV X-ray energy. The diffraction efficiency was about 12 %.

Experimental results were compared with theoretical calculations, which helped to improve the understanding of critical deposition parameters. Iteratively, it is possible to continuously improve caustic and beam profile.

Additional experiments with crossed multilayer Laue lenses were performed using a laboratory X-ray microscope in Dresden. The X-ray energy was 8 keV and the experiments yielded for the very first time a full-field image taken with multilayer Laue lenses. This first experiment already demonstrated resolution and contrast comparable to conventional zone plates.

It is expected that the time required for measurements will be reduced due to the higher efficiency and that the resolution of X-ray microscopy will improve due to the advantages of the fabrication process.

The Fraunhofer IWS is grateful for the support received from Fraunhofer IZFP, the Institute for Structural Physics of Condensed Matter at the Technische Universität Dresden and industry partner Global Foundries for the development support and characterization of multilayer Laue lenses.

- 1 SEM image section of depth graded multilayer Laue lenses including substrate (upper left) and transition to environment (lower right)
- 2 Ptychographically reconstructed phase image of a synchrotron experiment test sample with smallest structure dimensions of 30 nm
- 3 Ptychographically reconstructed phase image of a synchrotron experiment test sample with smallest structure dimensions of 30 nm

CONTACT

Dipl.-Phys. Adam Kubec
 phone +49 351 83391-3572
 adam.kubec@iws.fraunhofer.de





LASER ACOUSTIC TESTING MACHINE FOR THE SURFACE ANALYSIS OF SILICON BLOCKS AND SOLAR WAFERS

THE TASK

The solar industry substantially contributes to changing the way society manages energy resources. Silicon wafers are a basic component of solar modules. Such wafers are fabricated from silicon crystals, which are produced as blocks of about one meter in length and a cross section of 156 x 156 mm². The sidewalls of the blocks are essentially the edges of the wafers, which have to have minimal damage since such damage can cause crack formation. To reduce damage and minimize the potential for crack formation, polishing is applied to refine the sidewalls.

After sidewall polishing the brittle silicon blocks are cut into wafers using wire saws. This process leaves a damage layer along the cut wafer surface. The surface zone suffers high density microcrack damage. Such cracks reduce the strength of the wafer and must be completely removed prior to fabricating the solar cells. It is therefore desirable to optimize the sawing process to reduce the thickness of the damage layer. The optimization process would be significantly easier if there were a nondestructive method to determine the thickness of the damage layer.

A company of the solar industry and the Fraunhofer IWS Dresden were working on a method to determine the extent of material damage in silicon wafers caused by the sawing process of silicon blocks. The basis for this development is the nondestructive laser acoustic LAwave[®] method.

OUR SOLUTION

Surface acoustic waves are very sensitive to detect changes of material surface properties. A homogenous material without any surface modification will transport sound waves at a constant velocity. This wave velocity will not depend on the frequency but only on the material's density and modulus of elasticity.

This situation changes when the material has a surface region with properties different from the bulk. In this case the sound velocity changes with frequency (dispersion). The dispersion curve can increase if the surface region has a higher modulus of elasticity than the bulk material. Saw damage in silicon wafers reduces the modulus of elasticity on the surface compared to the bulk wafer. The crack pattern reduces the strength of this region. Subsequently the sound wave velocity will be reduced with increasing frequency. More damage will cause a steeper slope of this dependence.

The LAwave[®] method measures the dispersion curve of surface acoustic waves. These surface waves are excited on the surface in a line focus of short laser pulses. A piezoelectric sensor, in contact with the surface, receives the acoustic waves and converts them to electric signals, which are recorded by an oscilloscope.

RESULTS

Fig. 2 displays dispersion curves measured on solar wafers. The damaged material layer was removed step by step through reactive ion etching. The as-sawn wafer shows the

steepest reduction (slope) of the wave velocity versus frequency. The acoustic surface waves penetrate the wafer material less deep with increasing frequency. Thus the propagation of higher wave frequencies is more strongly affected by the damage layer. Each reactive ion etching step removes damaged material, which makes the remaining damage layer thinner. Consequently the slope of the dispersion curve gets smaller since the effect of the subsurface damage on the wave propagation reduces for all frequencies.

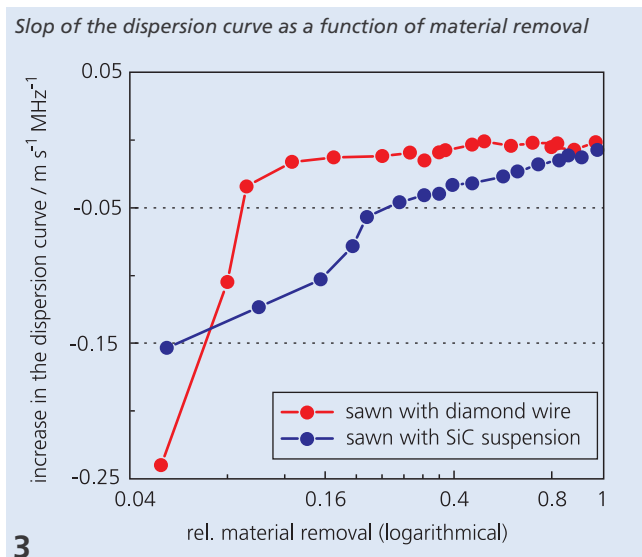
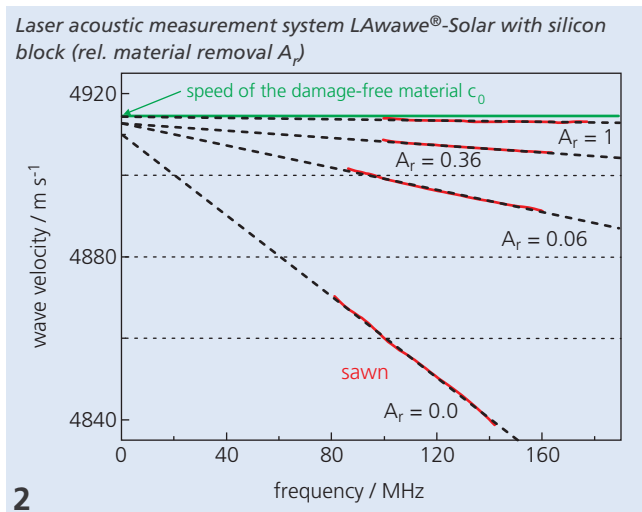

Thus it seems reasonable to utilize the slope of the dispersion curve as a measure for the thickness of the damage layer.

Fig. 3 shows how the slope of the dispersion curve changes with material removal. The diagram includes the results of two different sawing techniques, the sawing with diamond wire and with SiC suspension. The depth profile of the damage layers is clearly different for these techniques. Diamond wire sawing destroys the surface material more drastically than the SiC method but the damage layer depth is substantially smaller. Once the damage layer is removed the slope of the dispersion curve approaches zero.

The damage layer depth can be quantified using the LAwave® method by correlating the slope with actual thickness measurements. This calibration needs to be created for different sawing processes. The method can be used to derive detailed conclusions when optimizing the sawing processes.

Fraunhofer IWS engineers built a testing machine for a solar company, which can handle wafers of 10 g weight but also silicon blocks of about 50 kg. The focusing of the laser beam and the positioning of the sensor was automated using piezo motors. This makes the measurement process more efficient. A manual x-y table was integrated so that the lateral distribution of the damage can be recorded.

1 Laser acoustic measurement system LAwave®-Solar with silicon block

CONTACT

Dr. Dieter Schneider
 phone +49 351 83391-3451
 dieter.schneider@iws.fraunhofer.de



HEAD OF DEPARTMENT PROF. DR. CHRISTOPH LEYENS



"Do not go where the path may lead, go instead where there is no path, and leave a trail."

Jean Paul



BUSINESS FIELD THERMAL COATING AND ADDITIVE MANUFACTURING

Editor: You are coordinating the project "Additive Generative Manufacturing – The 3D Revolution for Product Fabrication in the Digital Age", which is one of 10 winners of the BMBF funded program "Twenty20 – Partnership for Innovation". What are IWS goals in this project?

Prof. Leyens: The generic term "additive generative manufacturing" describes novel processes to manufacture parts, tools, and models etc., which are created layer by layer (additive) by building up (generative) 3-dimensional material structures. These manufacturing processes place the right material at the right location with high precision, flexibility, resource efficiency and cost effectiveness without the need for much post processing. A consortium of 40 partners contributes to developing the additive generative manufacturing into a key technology for the next industrial revolution. To accomplish this, the BMBF will provide 45 million Euros in research funding.

Editor: Plastic parts and components made from other material can already be fabricated using 3D printers. What is the innovation in your project?

Prof. Leyens: The parts produced today with additive generative processes typically have to meet aesthetic specifications. In many cases it is not necessary that these parts have long lasting properties or stability. Our project however aims at making industrial parts. Specifications for mechanical strength, safety and costs are considerably more difficult. The project addresses the entire value chain and wants to make additive generative manufacturing processes available to many industry branches. The IWS contributes

multiple years of expertise. Already today we are delivering solution to our customers for fabricating individual parts as well as for series production. We are a driving force in the development of innovative 2D coatings and 3D structures.

Editor: How will additive generative manufacturing revolutionize the manufacturing?

Prof. Leyens: In the future we will have to worry less about the complexity of a given component. We will be able to fabricate a part optimized for its function without being limited by a manufacturing process. These new processes also afford the combination of different materials in ways that were impossible in the past. This opens another degree of freedom during the design phase of a part. Finally we will only use as many resources as are needed to produce the part itself. And if in 50 years somebody requires a spare part, we just use the CAD file and produce the replacement in original quality without much effort.

Editor: It looks as if meanwhile everything is revolving around additive generative manufacturing ...?!

Prof. Leyens: Indeed, at the IWS we have many competences and technologies, which are relevant for this highly attractive topic. We have a wide portfolio with wire and powder based laser processes, and printing and thermal spray technologies, which are useful not only for generating but also for coating with high precision and productivity.



COMPETENCES

THERMAL SPRAYING

The group offers atmospheric plasma spraying (APS), flame and high velocity flame spraying (HVOF and HVAF) technologies using powders and suspensions to coat parts made from steel, lightweight metals and other materials with metals, hard metals and ceramics. Core competences include the development of appropriate coating solutions that match application requirements, the development and fabrication of system components and their integration into adapted machine concepts. The implementation of technologies at the user is an important aspect of know-how transfer activities.

BUILDUP WELDING

The competences of this group include the complete application of laser wire and powder buildup welding processes for additive generative manufacturing and large area deposition. Also included are micro processing and surface functionalization. Generative manufacturing reaches beyond the aspect of direct component fabrication. The capability of quick turnaround design changes as well as repair of tools and components also plays an important role. Industrial customers benefit from the long-term experience of our group in the areas of process development, simulation, systems technology and onsite support during technology transfer. We also provide comprehensive consulting, education and training services.

PRINTING TECHNOLOGIES

Printing is a high precision and very reproducible process to deposit 2D and 3D structures on surfaces at low costs. The precise and flexible application of multi material systems and the additive generative building of micro components make products with radically new functionality and property profiles possible. Such innovative fabrication technologies are used, for example, to integrate printed electronics such as sensors, thermoelectric generators or energy storage devices into components.



HEAD OF DEPARTMENT

PROF. CHRISTOPH LEYENS

phone +49 351 83391-3242

christoph.leyens@iws.fraunhofer.de



GROUP LEADER THERMAL SPRAYING

PROF. CHRISTOPH LEYENS

phone +49 351 83391-3242

christoph.leyens@iws.fraunhofer.de



GROUP LEADER LASER CLADING

PROF. STEFFEN NOWOTNY

phone +49 351 83391-3241

steffen.nowotny@iws.fraunhofer.de



GROUP LEADER

PRINTING TECHNOLOGIES

DR. INES DANI

phone +49 351 83391-3405

ines.dani@iws.fraunhofer.de



2013 PROJECT EXAMPLES

1. Generative fabrication of metallic parts by
buildup welding with powders and wires 58
2. Material development for printing of flexible
thermoelectric generators 60
3. Materials science analysis of self-healing coatings 62
4. Increasing static friction through thermal
spray coatings 64
5. Spray pyrolysis of aluminum oxide to deposit
passivation layers on wafer materials 66



GENERATIVE FABRICATION OF METALLIC PARTS BY BUILDUP WELDING WITH POWDERS AND WIRES

THE TASK

Today the term “Additive Manufacturing” encompasses all processes that apply coatings onto surfaces as well as the generative fabrication and repair of parts. Laser buildup welding adding materials from powders and wires present an established base technology in this field.

In comparison to classic powder bed processes, the generative laser buildup welding process is limited in terms of geometric degrees of freedom. On the other hand, the laser process offers significantly higher buildup rates and the part size is not limited by the technique. Based on these characteristics laser powder buildup welding is today essentially used for repair tasks such as the rebuilding of engine parts, which often presents complex 3D problems.

The higher productivity and the larger work-piece dimensions associated with the laser buildup welding process are also of increasing interest to direct part fabrication. Powders as the buildup material are an important component for these processes since they offer a broad spectrum of available metal alloys and they are also available in composite form. However, a principle disadvantage is that not all of the powder can be deposited in the weld, leading to incomplete material utilization. This is also more and more critical in terms of potential health hazards related to process residues.

Wires present an increasingly interesting alternative as a source material. So far such wires were only used in handheld laser devices or in simple sideways processing heads with

limited contour and 3D capabilities. The qualification of laser buildup welding technologies as generative manufacturing processes requires the availability of suitable system components, which include central elements optical components and processing heads in addition to the laser itself.

OUR SOLUTION

The goal is to flawlessly build a metallic part with high precision directly from the CAD model. This requires stable system components that can feed powders and wires without any directional limitations. Coaxial powder nozzles are a long established and well working solution for powders. An omnidirectional wire feed however requires more technical effort to ensure long-term stable material delivery.

A new processing head is shown in Fig. 1. Wires with diameters from 300 μm to 1.2 mm are centrally fed along the laser beam axis. The material deposition occurs layer by layer in 2D sheets. Free 3D form deposition is also possible. The unit can be used in overhead or upside down working positions. Powder and wire processing heads with laser focusing optics are compact units. They are easily mounted in robot systems and CNC machines. In such machines the 3D buildup process is performed automatically following tailored buildup strategies.



RESULTS

The laser wire processing head shown in Fig. 1 is now also capable of welding contours and 3D buildups. The minimum wire diameter is 300 μm . The resulting minimum achievable lateral structure resolution is 600 μm . There are already a few metal alloys available that can be used for various technical applications. Examples are tool steel 1.2343, Inconel 625, Inconel 718, TiAl6V4 and alloys based on aluminum and copper.

Fig. 2 and 3 show sample parts, which were generated by laser wire buildup welding. The turbine blade with a height of 100 mm (Fig. 2) is hollow and made from Inconel 718. The microstructure is a fine crystalline casting structure free of defects and cracks. Particularly interesting is the low surface roughness across the individual layers of only $R_z = 63 \mu\text{m}$. This sample part was built using 1200 W laser power at a deposition rate of $51 \text{ cm}^3 \text{ h}^{-1}$.

The intake manifold shown in Fig. 3 is made from the aluminum alloy AlMg5. The microstructure is void of cracks and defects and the wall thickness of the part is 4 mm. This part was built with 2500 W of laser power at a deposition rate of $198 \text{ cm}^3 \text{ h}^{-1}$.

The so-called hotwire mode is a practicable method to further increase productivity with respect to buildup rate. By efficient electrical heating of the wire the buildup rates were increased to 200 %.

A representative sample part made by powder buildup welding is shown in Fig. 4. This is a metal leading edge (MLE) of a large compressor blade. These metal edges protect the fan blades in aircraft engines, which are made from a CFC composite material to reduce weight. In this case these edges are made from TiAl6V4. The particular

geometry is very difficult to make by casting or forming, which motivates their fabrication by generative laser buildup welding.

The shown part was made using a solid-state laser and a coaxial powder nozzle. During the process undesired reactions have to be avoided between the titanium powder and atmosphere. Therefore the complete process was performed inside a moving protective shielding gas chamber. The height of the blade is 650 mm, the wall thickness is 2.5 mm. The model-to-part accuracy depends on the location and ranges from +50 to +150 μm . The laser power was controlled online and comparatively low at 800 W. The deposition rate was $38 \text{ cm}^3 \text{ h}^{-1}$.

- 1 Coaxial laser wire buildup welding head for generative processing in robot systems
- 2/3 Sample components e.g. turbine blade (2) consists of Inconel 718 and suction bend (3) made of AlMg5
- 4 Means of laser powder deposition welding generative produced metallic leading edge from TiAl6V4

CONTACT

Prof. Steffen Nowotny
 phone: +49 351 83391-3241
 steffen.nowotny@iws.fraunhofer.de



MATERIAL DEVELOPMENT FOR PRINTED FLEXIBLE THERMOELECTRIC GENERATORS

THE TASK

The energy efficient utilization of available resources is not just limited to improving technical processes. It is also important to recover waste heat generated at each step. The total amount of waste heat is a substantial energy reservoir. Thermoelectric generators (TEG) can convert such heat to electrical energy and return it to the process. This will improve overall energy efficiency.

A classic TEG consists of two semiconductive materials with electron and hole charge carriers (n- and p-type semiconductors). Such a material combination generates an electric voltage between the warm and the cold side when being exposed to a temperature gradient (Seebeck effect, Fig. 2). Generated Seebeck voltages are on the order of only a few $\mu\text{V K}^{-1}$. However, if the semiconductors are connected in series, the voltage will add. The large area implementation of TEG requires low cost materials and high volume capable manufacturing technologies. Fraunhofer IWS engineers exploit printing technologies to deposit in-house developed and optimized thermoelectric materials.

OUR SOLUTION

Electrically conductive polymers are an interesting material class for flexible thermoelectric applications. Polymers can be processed with scalable printing techniques, which are capable of high volume manufacturing of thermoelectric generators.

Dispense printing is the particular technology of choice. The process does not require masking and is flexible with respect to variations of geometric parameters. Many pastes can be processed. The paste is fed through a fine hollow needle and dispensed by scanning the needle over the substrate.

A promising intrinsically conductive polymer for thermoelectric applications is PEDOT:PSS poly(3,4-ethylenedioxythiophene) poly(styrenesulfonate). The Seebeck coefficient of oxidized PEDOT:PSS is about $16 \mu\text{V K}^{-1}$. Adding 6 % by weight dimethyl sulfoxide (DMSO) increases the electric conductivity from 8 to 84 S cm^{-1} without negatively affecting the Seebeck coefficient.

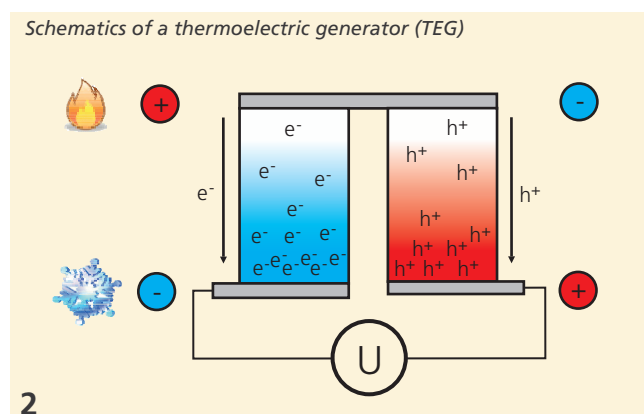



4



RESULTS

The substrate is a 75 μm thick polyimide foil. This flexible foil is stable at higher temperatures. The interconnecting conductors are made using silver print paste.

Internal resistance of a printed polymer TEG versus the number of thermocouples (silver-polymer)

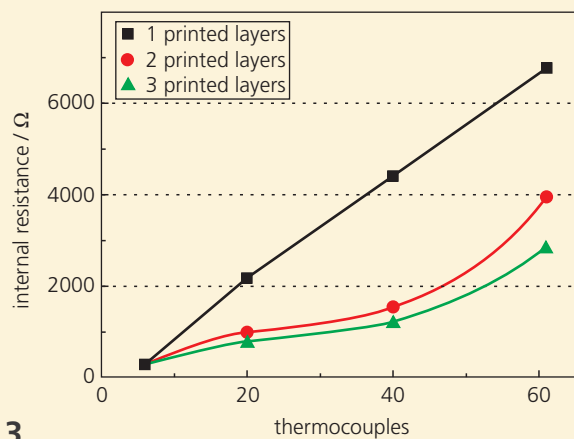

3

DMSO modified PEDOT:PSS is printed onto polyimide strips that are for example 300 mm long. This corresponds to 60 couples of silver and PEDOT:PSS. The printed structures are 1 mm wide and 10 mm long. The internal resistance of the TEGs can be reduced by printing multilayers of the material PEDOT:PSS (Fig. 3).

After drying and tempering the TEG strip is wound onto an adapter to characterize its performance (Fig. 4). It is placed between a heat source and a cold side. The latter is being held constant at 20 °C. The temperature on the warm side is increased step by step. With increasing temperature the open

circuit voltage of the TEG increases linearly. A temperature difference of 90 K generates 37 mV (Fig. 5).

Open circuit voltage of a printed TEG versus temperature difference

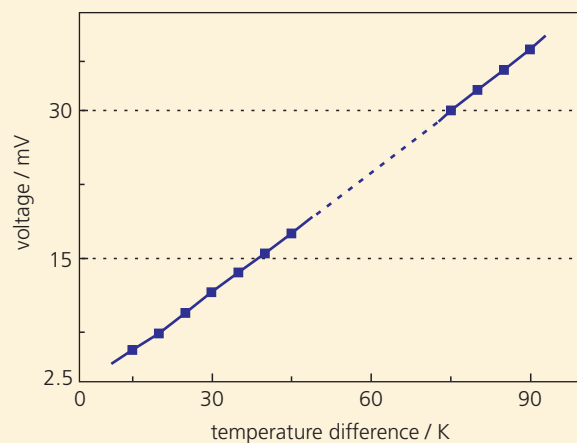

5

- 1 Printed TEG strip made from PEDOT:PSS and silver
- 4 Flexible TEG strip wound onto a testing adapter

CONTACT

M.Sc. Lukas Stepien
 phone +49 351 83391-3092
 lukas.stepien@iws.fraunhofer.de



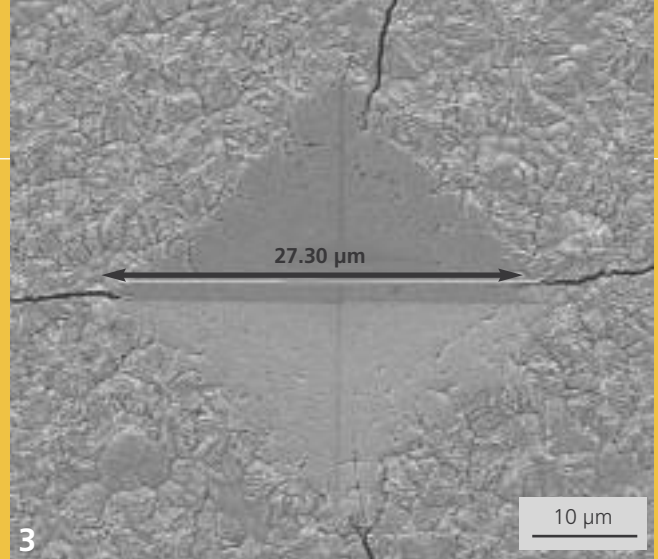

MATERIALS SCIENCE ANALYSIS OF SELF-HEALING COATINGS

THE TASK

“Self-healing” materials are capable of repairing internal defects such as cracks. The full or partial repairing process may occur completely intrinsically or upon an external trigger event. The goal is to heal the material to recover its original functionality [1]. It is not necessarily required that the healing process recreates the original microstructure. More importantly; the focus is on repairing the damage. The advantages of self-healing materials are obvious. The materials become more reliable and the lifetime of parts can be substantially increased. This is in particular interesting for components that are difficult to access. In such a case self-healing materials are enabling the potential to make the repair.

The DFG (Deutsche Forschungsgemeinschaft) priority program 1568 “Design and Generic Principles of Self-Healing Materials” has the goal to research the basic self-healing mechanisms of polymers and their composite materials, metals and ceramics. As part of this program scientists of the materials science department of the Technische Universität Dresden in collaboration with the Fraunhofer IWS and other partners are researching the self-healing potential of thin ceramic coatings. The research tasks focus on basic mechanisms to understand the relations between coating structures, the healing processes and the resulting properties of healed coatings.

OUR SOLUTION

Nanolaminate coatings, also named MAX-phases, were a focus of the research. This is a structural material class with properties that combine the advantages of metals and ceramics. These properties include chemical stability in corrosive and oxidizing environments, very good damage tolerance, stiffness, thermal shock resistance, good electrical and thermal conductivities, good plasticity and good machinability.

Such alloys are generally described by the formula M_2AX with M being a transition metal, A being an element from group A and X being either C or N. M_2AX -phases have a hexagonal structure with alternating A-metal and M_2X layers as shown in Fig. 1. An example of such MAX-phases is the system Cr_2AlC , which can be deposited using “high power impulse magnetron sputtering” (HPPMS) [2]. During the deposition, a self-organization process occurs forming a nanocomposite material.

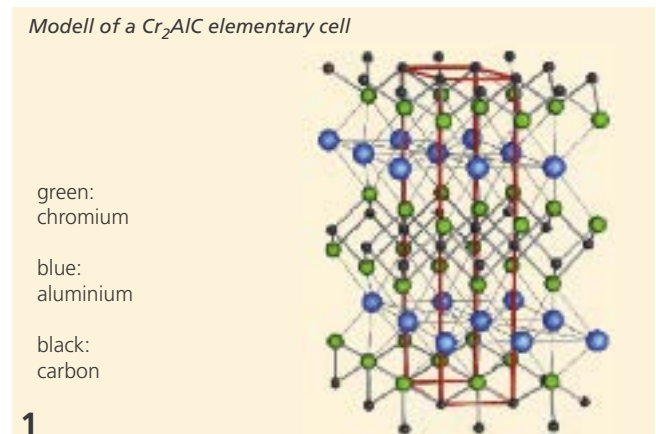

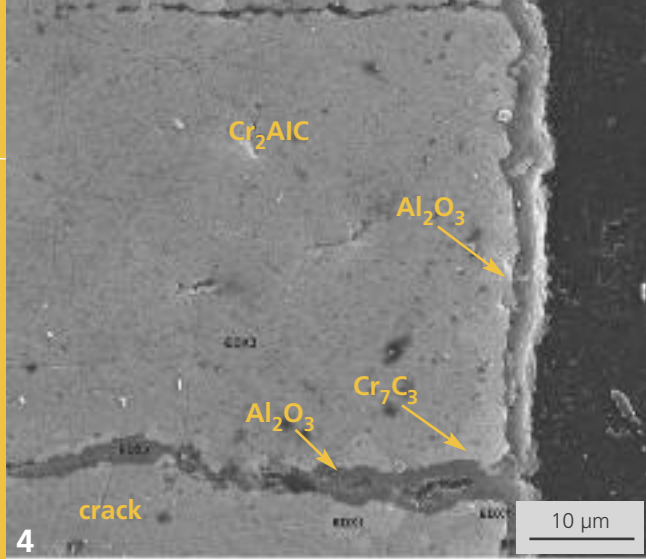

RESULTS

Cracks may form when using the coated part, as a result of erosion for example (Fig. 2a). Continuing erosion leads to the formation of a crack network, which consequently leads to coating delamination (Fig. 2b). Refilling the cracks after they form prevents the loss of the coating (Fig. 2c).

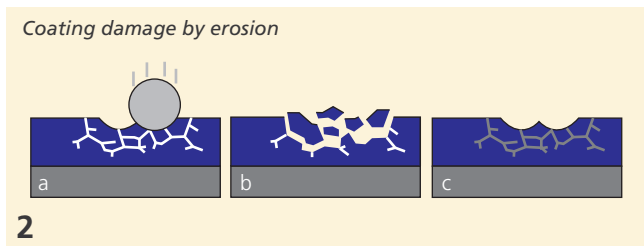

A Vickers indenter was used to create cracks of defined geometry in Cr_2AlC coatings (Fig. 3). In a subsequent healing process these cracks were then closed. This was achieved by heat-treating the coatings for various durations at temperatures between 700 and 1200 °C. During this exposure to heat, the crack flanks react with oxygen and form aluminum oxide. Given proper process parameters the entire crack volume can be filled (Fig. 4).

By adding small amounts of yttrium to the Cr_2AlC coatings it is possible to control the speed of crack healing and the mechanical quality of the "scar" (aluminum oxide) [2]. Yttrium positively affects the adhesion as well as the growth rate of the aluminum oxide. It also supports the formation of thermodynamically stable $\alpha\text{-Al}_2\text{O}_3$, which is the most wear resistant form of aluminum oxide at high temperatures.

The projects partners also studied sintered bulk Cr_2AlC samples. Repairing the cracks with aluminum oxide yields mechanical properties that are equivalent to the original Cr_2AlC sample. Proving this for thin film coatings is much more complicated and the subject of current studies.

The research of self-healing mechanisms of materials is the subject of the research program 1568 "Design and Generic Principles of Self-Healing Materials". The German Research Foundation (DFG) has funded this program since 2011. This project is a very good example for the "Dresden concept". Basic research at the TU Dresden is combined with application oriented work at the Fraunhofer IWS.

- 3 *Macroscopic cracks in a Cr_2AlC coating, introduced by a Vickers indenter*
- 4 *SEM image of a crack filled with aluminum oxide*

- [1] M. D. Hager, P. Greil, C. Leyens, S. van der Zwaag, U. S. Schubert: *Self-Healing Materials, Advanced Materials* 22 (2010) 5424–5430
- [2] O. Berger, C. Leyens, S. Heinze, M. to Baben, J. M. Schneider, *Self-healing of yttrium-doped Cr_2AlC MAX phase coatings deposited by HIPIMS, Proc. 4th Int. Conference on Self-healing Materials (ICSHM 2013), Ghent, Belgium, 2013, p. 319-323*

CONTACT

Prof. Christoph Leyens
 phone +49 351 83391-3242
 christoph.leyens@iws.fraunhofer.de





INCREASING STATIC FRICTION THROUGH THERMAL SPRAY COATINGS

THE TASK

Thermally sprayed hardmetal coatings are mostly used for wear protection to reduce the deteriorating effects of abrasion, erosion and sliding wear. The most important goal is to minimize friction and wear of the parts in lubricated and dry sliding condition including high temperature conditions of up to 900 °C.

However, applications that require high friction coefficients are less typical for such coatings. There are few applications such as a frictionally engaged clutches between rotor shaft and transmission in wind power generators. The clutch uses an assembly of friction pads, which are coated on both sides. This research aims to further increase the friction of thermal spray hard metal coatings with the particular goal to reduce the scattering of the friction coefficients.

Another objective of the work is to better understand the basic mechanisms which lead to increased friction. Such results are beneficial to develop reliable and less costly solution for industrial applications.

OUR SOLUTION

First experiments were performed with coatings made from Cr_3C_2 -NiCr and (Ti, Mo) (C, N)-Ni. Both material combinations have roughly equal volume fractions of hard materials and binder metals. The Cr_3C_2 -NiCr coatings were previously found to have high sliding friction coefficients in dry conditions when running against sintered aluminum oxide or self-mated. (Ti, Mo) (C, N)-Ni coatings on the other hand had relatively low friction coefficients.

The coatings were deposited with a liquid fuelled HVOF process. Commercial Cr_3C_2 -NiCr and experimental (Ti, Mo) (C, N)-Ni powders were used. The test substrates were made from quenched and tempered 42CrMo4 steel. These samples are shown in Fig. 1 as they appeared after the test. The effective contact area is along the upper face edge of the samples and ring shaped. The inner diameter $D_i = 15$ mm and the outer diameter $D_o = 30$ mm.

The coatings were sprayed with an optimized parameter set and had a thickness of 300 μm . Their performance was investigated as-sprayed, without any post processing. The surface roughness's were $R_a = 6.0$ μm and $R_z = 32.2$ μm for the Cr_3C_2 -NiCr coatings and $R_a = 3.9$ μm and $R_z = 22.3$ μm for the (Ti, Mo) (C, N)-Ni coatings.

A 3D analysis method was used to determine the geometric properties of the coatings such as shape, waviness and roughness. The friction experiments were performed at a special test stand located at the TU Chemnitz using nominal contact pressures of 30, 100 and 300 MPa.

RESULTS

Fig. 2 shows the friction coefficients $\mu_{0.1}$ and μ_{max} as a function of the contact pressure, which were calculated from slip curves. The $\mu_{0.1}$ friction coefficient is measured at a relative torsion angle of 0.1° and μ_{max} is calculated from the maximum torque of the slip curve for torsion angles depending on the experiment.

The friction coefficients are highest at 300 MPa contact pressure. Data are also less scattered at higher contact

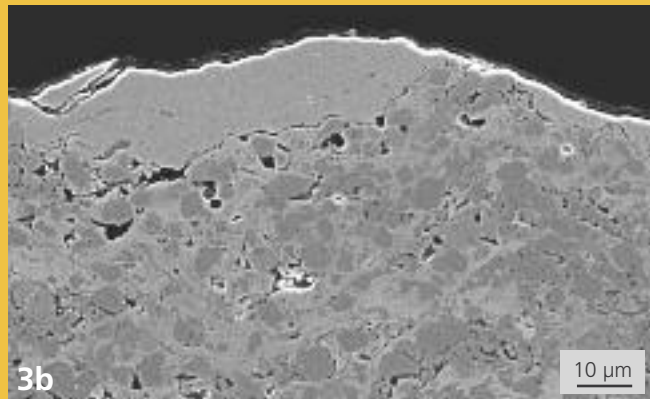
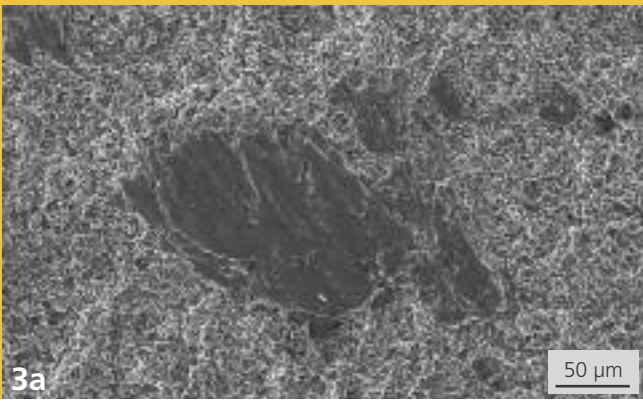

pressures. Although the shapes of the slip curves differ for $\text{Cr}_3\text{C}_2\text{-NiCr}$ and $(\text{Ti}, \text{Mo})(\text{C}, \text{N})\text{-Ni}$ coatings their friction coefficients are comparable.

Fig. 3a shows an SEM image of the as-sprayed rough $\text{Cr}_3\text{C}_2\text{-NiCr}$ coating after friction tests were performed with 30 MPa contact pressure. The dark area in the center is material transferred from the counter face material. Fig. 3b shows the same material transfer at 300 MPa in cross section.

The material transfer increased with increasing contact pressures. The number and the size of contact areas where

the material transfer occurred were increasing with contact pressure. This behavior occurred for both coating compositions.

No damage of the coatings themselves was observed. Those areas of the coatings that were not covered with material from the counterpart were unchanged and appeared as sprayed. This result also indicated the very good bonding of HVOF sprayed hardmetal coatings to the substrates.

The here presented experiments were funded within a AiF/DFG program (12N10063) in cooperation with the Engineering Design and the Institute of Production Measuring Technology and Quality Assurance at the TU Chemnitz.

Dependence of the friction coefficients $\mu_{0,1}$ and μ_{max} as a function of the contact pressure for $\text{Cr}_3\text{C}_2\text{-NiCr}$ and $(\text{Ti}, \text{Mo})(\text{C}, \text{N})\text{-Ni}$ coatings

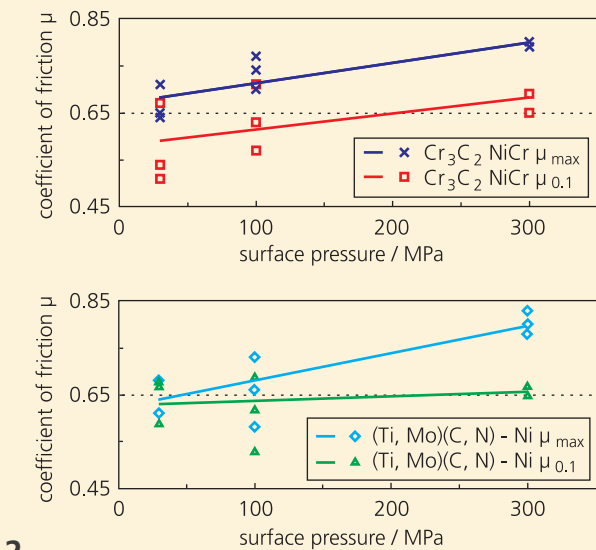

- 1 Test sample with $(\text{Ti}, \text{Mo})(\text{C}, \text{N})\text{-Ni}$ (left) and $\text{Cr}_3\text{C}_2\text{-NiCr}$ (right) hardmetal coatings after friction tests
- 3 $\text{Cr}_3\text{C}_2\text{-NiCr}$ coating surface after friction testing at 30 MPa contact pressure
 - a) Top view
 - b) Cross section

CONTACT

Dr. Lutz-Michael Berger
 phone +49 351 83391-3330
 lutz-michael.berger@iws.fraunhofer.de





SPRAY PYROLYSIS OF ALUMINUM OXIDE TO DEPOSIT LAYERS ON WAFER MATERIALS

THE TASK

Alternative concepts are sought for the backside passivation of lower cost solar cell wafers. Conventional passivation is based on using aluminum paste and a screen-printing process. However, this layer is causing wafer bending in subsequent heat treatment steps during cell fabrication. This can be avoided by using an aluminum oxide thin film as a passivation layer. Aluminum oxide layers have a high fraction of negative charge carriers, which is especially suitable for field effect passivation in p-doped silicon surfaces.

Typical methods for high quality aluminum oxide film deposition on silicon are atomic layer deposition (ALD) and plasma enhanced chemical vapor deposition (PECVD). The task is to develop an alternative process operating at atmospheric pressure. The focus is on using safe, easy to use and low cost precursors for the deposition. The use of vacuum chambers should be avoided and the process should be scalable and suitable for inline installations. High deposition rates are essential to manage a throughput of 3600 wafers per hour.

OUR SOLUTION

Fraunhofer IWS engineers are developing an ultrasonic spray pyrolysis process for the deposition of aluminum oxide films. The spray process works at atmospheric pressure in air or nitrogen. An ultrasonic nozzle (frequency 120 Hz, flow rate 1 ml min⁻¹) atomizes the precursor solution. Due to the nitrogen flow the produced aerosol forms a hollow cone and is guided toward the heated substrate.

Shortly before reaching the substrate the aerosol transforms to its vapor phase. Subsequent vapor deposition forms the aluminum oxide on the substrate surface. A thermocouple measures the temperature in the heated graphite holder. The ultrasonic nozzle is scanned across the substrate by a 2-axes linear motor system, which creates a homogeneous spray pattern.

Schematics of the spray chamber

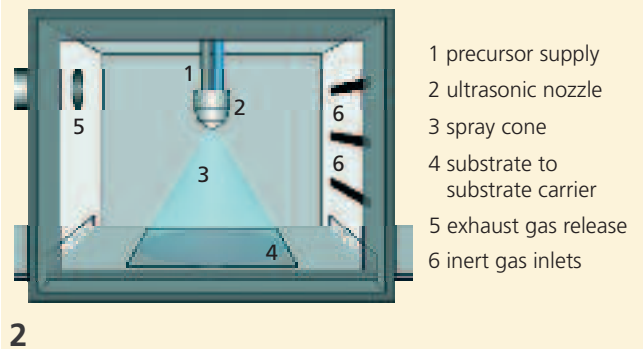

RESULTS

The test precursor solution was composed from a mixture of aluminum acetylacetonate, methanol, diethylene glycol monobutyl ether and 3 or 33 % water. The films were deposited onto 156 mm x 156 mm substrates, which had reference films of aluminum oxide (ALD) on the backside.

Microwave detected photoconductivity measurements (MDP) were performed to evaluate the coating quality. The measurements determine the effective charge carrier lifetime (LTL) with spatial resolution in passivated p-type (1 - 5 Ω cm) CZ-silicon wafers (525 μm thick).

The effective charge carrier lifetime on wafers with sprayed aluminum oxide films was 260 μs (Fig. 3). This results in an effective recombination speed of 113 cm s^{-1} . This speed is determined by the sprayed aluminum oxide coating. The substrate temperature during the deposition process is 340 $^{\circ}\text{C}$. Subsequently a thermal annealing step for the sprayed coatings to activate the aluminum oxide coatings is not necessary.

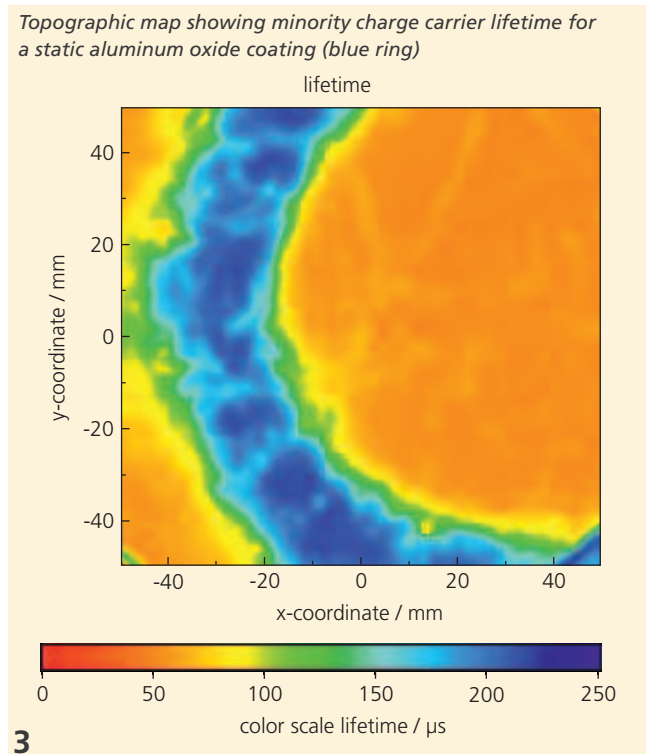

The aluminum oxide coating should have a thickness of about 15 - 20 nm for optimum passivation. The deposition rate with the used precursor mixture was 16.6 nm min^{-1} , which is comparable to typical PECVD deposition rates. No particle contamination of the coating occurs during the deposition. The average roughness of the coating is 0.55 - 0.59 nm.

The water vapor concentration increase from 3 to 33 % improved the passivation effect of the pyrolysis sprayed aluminum oxide coatings. A high water vapor fraction improves the defect saturation with hydrogen at the interface $\text{AlO}_x/\text{SiO}_2$ (chemical passivation).

Spray pyrolysis is also useful to deposit other coating systems such as transparent conductive films (TCO).

The results were obtained within the project S-PAC – Saxony Photovoltaics Automation Cluster – Chemnitz/Dresden (03WKBW03C). This project is part of the BMBF initiative “Innovative Regional Growth”.

1 *Ultrasonic nozzle with
heat sink*

CONTACT

Dipl.-Ing. Dorit Linaschke
phone +49 351 83391-3295
dorit.linaschke@iws.fraunhofer.de



HEAD OF DEPARTMENT PROF. DR. BERNDT BRENNER



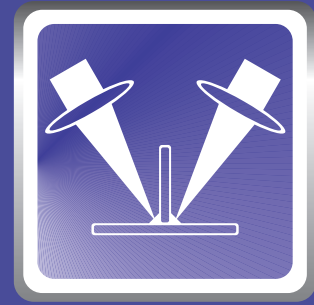

"The Future is what we make of it"
International Wisdom

BUSINESS FIELD JOINING

Editor: Prof. Brenner, last year you established the new workgroup "Component Design". What are your expectations in this area?

Prof. Brenner: Foremost we see this step as a strategic development of the business field "Joining". However, we also expect benefits for the business field "Surface Technologies" and the competence area "Materials Characterization". Basically we want to advance multiple areas at the same time.

For example, the complex requirements to efficiently use energy and resources in combination with future mobility concepts lead to the increasing use of lightweight designs. We have many years of experience in developing joining processes for hard-to-weld material combinations as well as in characterizing materials and components. This provides ideal conditions to further complete the research and development chain with a competence field addressing materials, process, and application tailored component design.

We are very excited that this competence area is well received by our industrial customers. An example is the development of a new bumper for railroad vehicles. The lightweight web-plate/slit design is built with laser welded steel sheets, whereby the components were optimized using computer simulations. As a result the manufacturing costs were cut by more than 50 % while simultaneously reducing the overall weight (see page 74).

Editor: Are you planning the design of CFRP structures, which appear to be changing construction methods in the automotive industry?

Prof. Brenner: Yes, indeed. This field is a current development target for many players in various industry branches. In a first step we are concentrating on the

development of mostly automated technologies to fabricate CFRP/metal hybrid joints for highest loading conditions. This is an area that is currently lacking attention. Such development goals especially require numerical simulations of the different mechanical loading profiles to obtain the requirements for the joining technology, the joint designs and the geometry of the joining zone. The first development task is a special highly loaded shaft-hub joint for a lightweight automotive design, which will be manufactured using a novel joining technology.

Editor: What are the next steps for the laser multi pass narrow gap welding process?

Prof. Brenner: Here we have accomplished an essential development step. A 30 mm thick plate from a hot crack sensitive aluminum alloy was welded crack-free with a 4 kW laser. The flawless welding of thick plates prone to hot cracking is a field that has not even been approached by electron beam welding technologies. Future efforts aim at increasing the process efficiency, developing related systems technology and at developing welding technologies for plated materials and large components.



COMPETENCES

WELDING OF HARD-TO-WELD MATERIALS

Laser welding is a broadly established manufacturing technology; particularly for high volume production. Laser welding processes are available with integrated short-term heat treatment, with specially adapted filler materials and with high frequency beam manipulation. Such process capabilities facilitates a new approach to welding crack free joints in hardenable and high strength steels, cast iron, aluminum and special alloys, hot crack sensitive alloys and components with high stiffness. The group has a strong background in systems as well as in metal physics, and its offer includes the development of welding technologies, prototype welding, process and system optimization and the development of welding instructions.

SURFACE CONDITIONING AND CONSTRUCTIVE ADHESIVE BONDING

Plasma and laser surface conditioning is frequently used to prepare surfaces for better wetting behavior for adhesives, which ultimately results in higher bond strengths. Contact angle, roughness and coating thickness measurements are used to characterize such surfaces and adhesive bonds. Optical microscopy, SEM/EDC and spectroscopic methods are applied as well. The integration of carbon nanotubes into adhesives can increase the bond strength and also make the adhesive bond electrically conductive. The group offers conditioning processes and characterization of surfaces used in adhesive bonding. Constructive adhesive bonding is offered for various materials. Bond strength measurements and ageing studies can be performed. Consulting is offered on all topics of adhesive bonding.

SPECIAL JOINING PROCESSES

Conventional standard melt based welding processes often reach their limitations when it comes to welding of modern functional materials. For metals, this is for example the case for welding high strength aluminum alloys. The problem is even more critical when a joint is desired between different metals such as aluminum and copper. In such a case the melt during the welding process forms intermetallic phases, which severely reduce the mechanical strength of the joint. The group therefore focuses on developing joining processes that do not require melting the materials and thus avoid the associated problems. The primary focus is on friction stir welding, laser beam soldering, laser induction roll plating, and electromagnetic pulse welding. The offer includes process development, prototype welding and systems development.

COMPONENT DESIGN

The combination of increasing application requirements for components, the use of innovative materials and of new manufacturing processes, usually also demands new component design approaches. The group supports the customer to successfully implement Fraunhofer IWS developed joining and heat treatment technologies by offering structural mechanical FE simulations, thermo-mechanical calculations as well as experimental verification. The goal is to tailor and optimize the component design to best suit the customer's processing and application specifications and load conditions. Such solutions are closely connected with process development and materials characterization.



GROUP LEADER WELDING

DR. JENS STANDFUSS

phone +49 351 83391-3212
jens.standfuss@iws.fraunhofer.de



HEAD OF DEPARTMENT

PROF. BERNDT BRENNER

phone +49 351 83391-3207
berndt.brenner@iws.fraunhofer.de



GROUP LEADER BONDING

DR. IRENE JANSEN

phone +49 351 463-35210
irene.jansen@iws.fraunhofer.de



2013 PROJECT EXAMPLES

1. New approaches for developing laser beam brazing 72
2. Design of crash components suitable for laser processing and application requirements 74
3. Laser beam welded aircraft fuselages made from high strength aluminum lithium alloys 76
4. Laser beam welding of highly loaded components made from blackheart malleable cast iron 78
5. Automated laser beam welding of tube/tube sheet joints 80
6. Structural analysis of Al-Cu joints for electromobility 82
7. Vacuum suction blasting as an effective surface conditioning method for adhesive bonding 84

GROUP LEADER

SPECIAL JOINING TECHNOLOGIES

DR. GUNTHER GÖBEL

phone +49 351 83391-3211
gunther.goebel@iws.fraunhofer.de



GROUP LEADER

COMPONENT DESIGN

DR. AXEL JAHN

phone +49 351 83391-3237
axel.jahn@iws.fraunhofer.de



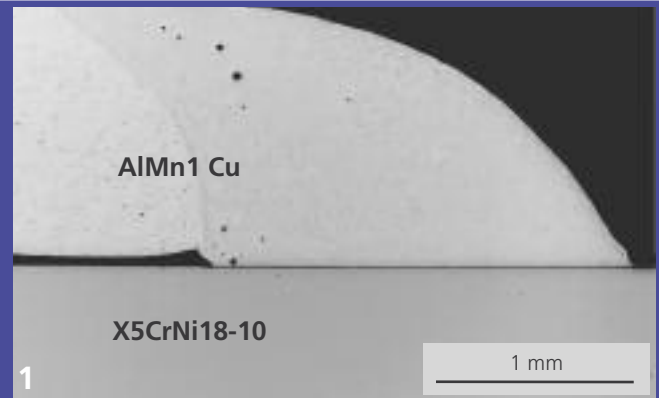

NEW APPROACHES FOR DEVELOPING LASER BEAM BRAZING

THE TASK

Joining sheet metal with high surface quality weld seams is important to many industries. Numerous techniques exist therefore to efficiently address this task. However, many of these approaches fail when the seams consist of dissimilar metals or if the demands for surface quality are very high.

Laser beam brazing is one of the few methods that are known to address this challenge. The method is established in automotive body making where similar visible metals need to be joined. Existing brazing techniques are reaching their limits with respect to brazing speed and robustness, which is particularly true for situations requiring dissimilar metals. The task is therefore to apply the latest laser processing techniques to develop new methods for linear joining of metal sheets along freeform contours.

OUR SOLUTION

Classic techniques such as flame and induction brazing heat both joining partners and then introduce the braze using the capillary effect due to the gap between them. Laser brazing instead primarily heats the braze. The surfaces to be joined are also activated. Typical geometries that work for this method are overlapping joints and butt welds between plates with raised edges.

The capillary effect that is used for classic brazing is of lesser importance. The braze is wetting those surface areas that are directly exposed to the laser beam. The amount of the energy supplied by the laser is critical for the wetting behavior.

The required distribution of laser energy varies greatly by location, in particular for situations with at least two dissimilar materials to join and the additional brazing material. The shape and energy distribution in the laser spot is of central importance for such processes. A simple disk shaped focus with a standard energy distribution, as used in most conventional laser brazing systems, will yield only suboptimal results. Fraunhofer IWS engineers are testing in-house developed optical systems to deflect, shape and control the laser beam. Such systems are widely deployed in laser beam hardening machines across industries. The concept is to adapt those to the requirements of laser brazing.

High-speed thermography and videography systems are additionally used to understand the correlation between process parameters, the highly dynamic braze melt flow and the resulting seam quality. This method is useful to improve braze results for steel/steel joints. It is especially beneficial to study the behavior when brazing dissimilar metals due to the complex melting behavior.

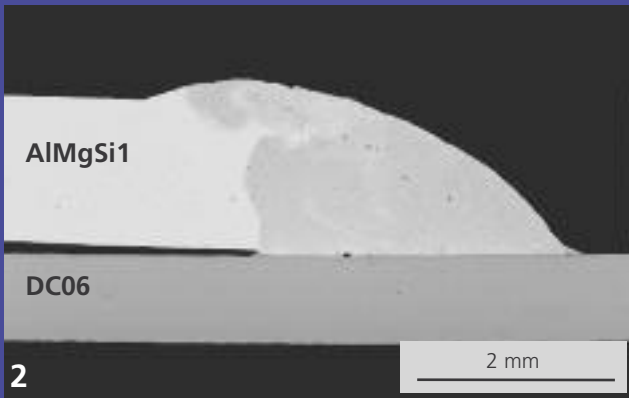

RESULTS

Numerous dissimilar material joints were laser beam brazed and analyzed. The results show that optimizations of laser spot geometry and energy distribution help to improve the seam quality. An elongation of the spot shape toward the direction of brazing proved to be especially beneficial. The energy density distribution needs to be adjusted in the front and rear areas depending on wire thickness and type. Common applications include aluminum / steel mixed joints (Fig. 1-3).

Even optimized parameters cannot avoid the formation of critical intermetallic phases since the metals also diffuse during laser beam brazing. The primary optimization goal is therefore always to reduce the thickness of intermetallic phases to non-critical values, which is typically achieved when they remain thinner than five micrometers. This is more easily achieved using the flexible laser processing tool. It is, for

example, possible to maintain constant surface activation energy in the front part of the beam spot whereas the braze melting energy can be adjusted based on speed. Changes in melting and wetting behavior become readily visible using the analysis tools, Fig. 4.

Using the optical analysis tools to study the effects of adjusting spot geometry and energy distribution helped to develop a very effective and flexible laser brazing method, which results in significantly improved seam quality.

1-3 Examples of brazed mixed material joints

Individual frame of a high speed process analysis; the melting behavior, wetting and oxidation is clearly visible.



4

CONTACT

Dr. Gunther Göbel
 phone: +49 351 83391-3211
gunther.goebel@iws.fraunhofer.de





LOAD ADAPTED DESIGN OF CRASH COMPONENTS FOR RAILWAY VEHICLES

THE TASK

Modern railway vehicles have to be manufactured and operated at reasonable costs. They also have to be very safe and functional. Fraunhofer IWS engineers participated in the development of a new lightweight tramcar. The specific task was to develop a new crash bumper design suitable for low cost manufacturing and capable of handling the desired application loads. In a case of a crash, the bumper should absorb the entire energy and transfer it to crash absorbers without encountering any noticeable plastic deformation. A particular design requirement was that the bumper would not climb or override the next tramcar in case of a tram versus tram crash.

For the new development the following goals were defined:

- to reduce the fabrication effort
- to reduce the materials costs
- to avoid an increase of component mass
- guaranteed crash resilience
- override protection

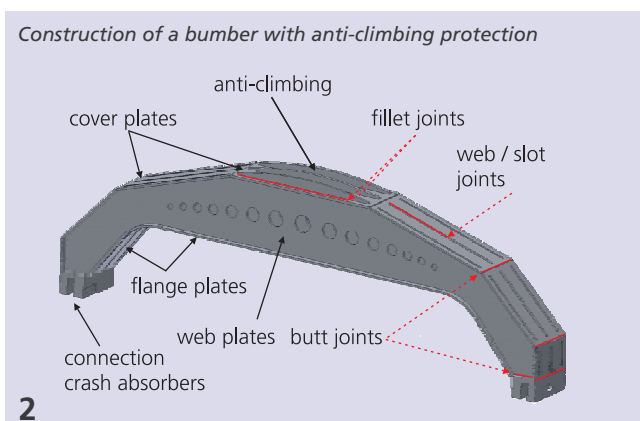

OUR SOLUTION

The Fraunhofer IWS design is based on a laser welded web / slot design made from 4-8 mm thick sheets of fine grain steel S355N (Fig. 1). The cover and flange plates have slots to insert three web-plates during assembly. Once assembled, the web-plates are laser welded from the outside. In the middle section the web-plates penetrate the coversheet and thus form the override protector. The design effort focuses on simplifying manufacturability of the individual components, which are mostly flat metal sheets. Long and externally accessible weld seams help to reduce fabrication costs. Structural stiffness is achieved by the braced box construction.

RESULTS

The dimensioning of the construction was based on the crash simulations. Frontal and frontal-side crash situations were simulated applying actual crash forces and scenarios (Fig. 3). The implicit PAM-CRASH solver code simulated the crashes for

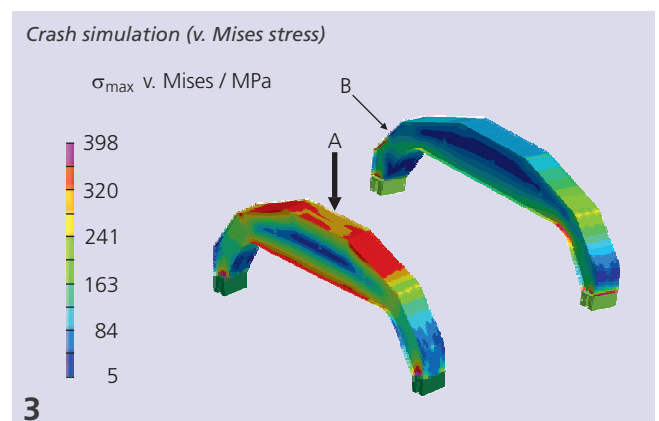

pure elastic material behavior. The calculated stress distributions and part deformations were analyzed and the component design was iteratively improved. A boundary condition during this optimization was to minimize the component mass.

The manufacturing concept aims at minimizing the effort to fabricate a part with high quality by utilizing a mechanized process flow. The individual metal sheets, the slots in the cover sheets and the feedthrough elements of the web-plates are made by laser cutting. The assembly of the box structure is done manually using spot tacking to safely position the individual parts.

The construction is laser beam welded from outside. The web / slot joints are laser welded with a laterally deflecting beam over the whole web-plates. (Fig. 4 left). If the web-plates are especially thick ($t = 8 \text{ mm}$) two weld seams may be applied.

Double sided fillet seams are applied in the region of the override protector (Fig. 3 right). Flange coversheets as well as the connections to the crash absorbers are welded with butt joints. Gaps of up to 1 mm may occur caused by part and assembly tolerances. In this case additional filler materials are required during welding.

The development result is a novel bumper concept for trams suitable for low cost manufacturing and able to handle the required loads. The design is based on combining sheet metal with web-plate and slot construction principles. The manufacturing costs (materials + fabrication) were reduced by more than 50 %. The new design has the same weight as the original and performs comparable in crash tests. Necessary functions were incorporated such as integrated override protection and interchangeable connectors to crash absorbers.

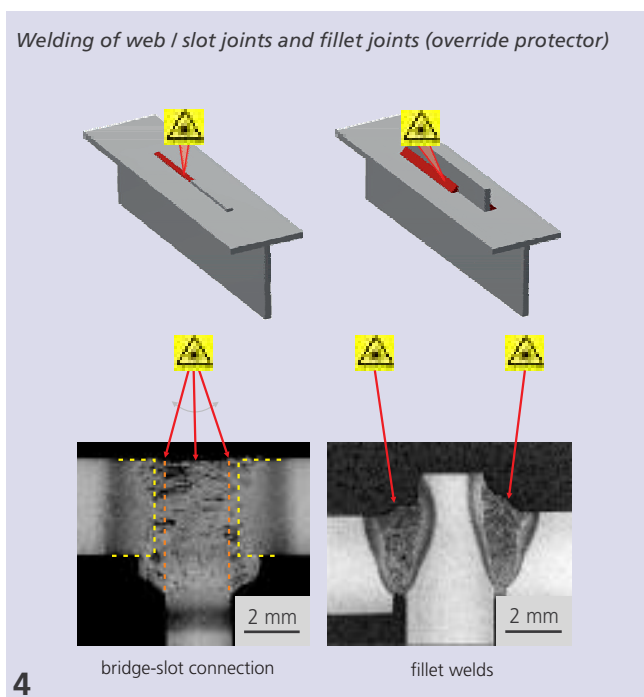

1 Tram design

CONTACT

Dr. Axel Jahn
 phone: +49 351 83391-3237
 axel.jahn@iws.fraunhofer.de



LASER BEAM WELDING OF AIRCRAFT FUSELAGES MADE FROM HIGH STRENGTH ALUMINUM LITHIUM ALLOYS

THE TASK

A number of innovative products for long-distance passenger aircrafts have been developed in recent years, in particular in the area of fuselage structures. Manufacturers using metal structures benefit from the introduction of laser technology to weld high-strength aluminum alloys. Smaller planes such as regional jets are now experiencing a similar innovation thrust. The weight has to be reduced in order to meet emission restrictions, and for manufacturing smaller planes this implies an even higher cost pressure.

The weight-to-cost target is very well met with the aluminum lithium alloy 2198, which has a lower mass density, a higher elastic modulus and a higher mechanical strength as previously used aluminum alloys. The Fraunhofer IWS participated in the EU project "Clean Sky". The task was to develop welding concepts for the lower part of an aircraft fuselage structure made from the 2198 alloy. Part design and laser welding process had to be developed and a lower fuselage panel with reduced weight had to be fabricated.

OUR SOLUTION

In a first step a lower fuselage panel of 1600 x 900 mm² was designed as a CAD model using classical calculation methods. Starting with this model, so-called T-butt joints were defined as smaller test areas for testing processes to weld the hard-to-weld 2198 alloy. Numerous small samples were welded and mechanically tested under static and cyclic conditions.

The low thickness of 1.2 mm of the skin sheets in the area of the weld seam was a particular challenge. The laser has to be very

precisely controlled to minimize the thermal effect of the weld seam on the appearance of outside panel.

Stringer strip samples made from the 2198 alloy and welded with optimized parameters were analyzed for mechanical load resilience (Fig. 2 a). These were idealized samples. Their purpose is to validate the preliminary finite element model (Fig. 2 b). The results were then applied to develop the final finite element model for calculating the entire panel and estimating panel buckling and panel failure loads.

The finite element model was subsequently geometrically expanded to enable complex calculations for weight optimization with respect to load handling capability. The structure was optimized for compression loads and the CAD model was refined to implement a welding solution. Fixtures were designed and the welding strategy was tested. The 5-stringer panel was fabricated as a testable demonstrator.

RESULTS

The welding process requires double-sided simultaneous laser beam welding. Two CO₂ laser beams are oriented at low angles with respect to the skin sheet to weld the stringer. Prior to the welding processes, the material surface is wet chemically cleaned. The material is also typically sensitive to form hot cracks, which can be avoided by using adapted weld filler materials.

A finite element simulation was performed for a 1600 mm x 900 mm metallic structure with 5 stringers, 3 frames, a minimum skin sheet thickness of 0.9 mm and a weight of less than 7 kg. The result showed that this panel would still

withstand the required maximum load as well as overloading (Fig. 2 c)

An experimental pressure test was performed with the panel at the Fraunhofer Institute LBF in Darmstadt. Similar to the simulation, the panel was mounted in a tenter frame and compression loaded. The resulting buckling behavior and critical failure loads were determined as shown in Fig. 2 d

manufacturing. To exploit this lightweight design technology for the actual manufacturing of regional jets, it is necessary to perform a barrel test in a next step.

Compression load and simulation model of a 1-stringer strip sample and a 1600 x 900 mm² test panel

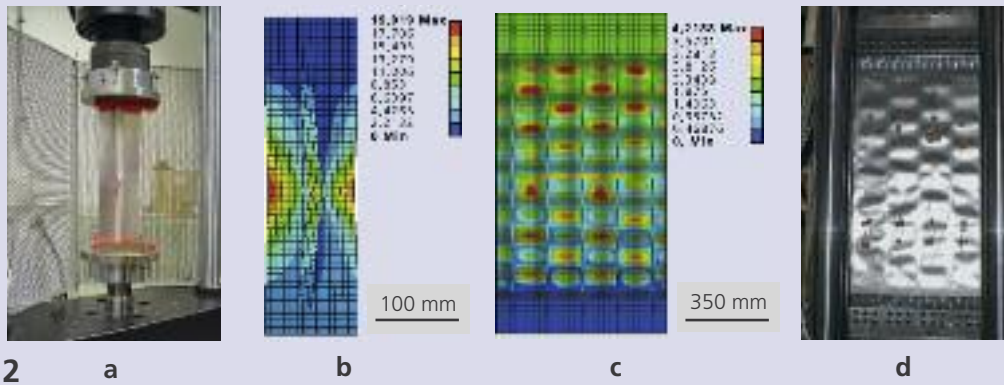

The finite element simulation conservatively estimated a critical failure load of 99 kN. The experiment yielded a slightly higher failure load of 103 kN.

Therefore the boundary conditions used in the finite element model proved to be acceptable. It was also demonstrated that it is possible to fabricate a lightweight panel from the high-strength aluminum lithium alloy 2198, which reliably withstands the required loads.

The Fraunhofer IWS welding technology for very thin walled and large test structures is also suitable for cost efficient

1 Passenger aircraft

CONTACT

Dr. Dirk Dittrich
 phone: +49 351 83391-3228
 dirk.dittrich@iws.fraunhofer.de



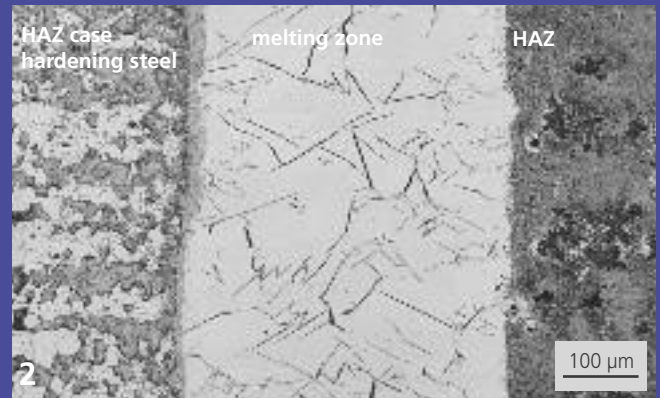
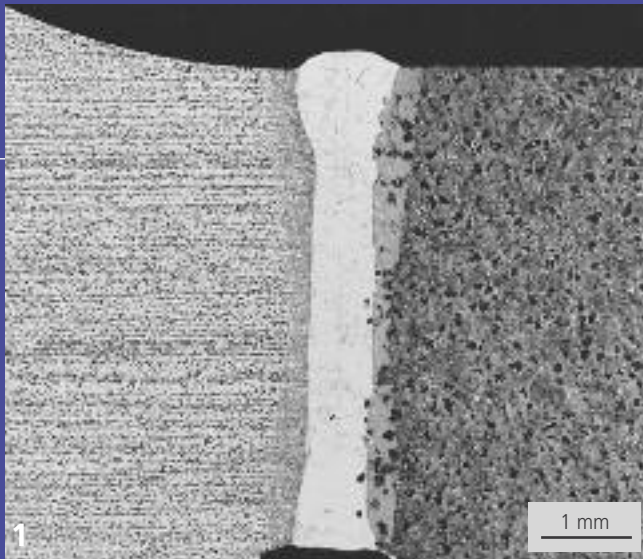

LASER BEAM WELDING OF HIGHLY LOADED COMPONENTS MADE FROM BLACKHEART MALLEABLE CAST IRON

THE TASK

For more than 15 years mixed joints from case hardened steel and cast iron have increasingly become the worldwide standard for automotive transmissions. Previously the joints, especially in differential transmissions, were very complex screwed and riveted connections, which were more difficult to fabricate and also heavier.

However, the general industry pressure on costs and quality continues. Highly cyclic loading resilient globular cast iron (GJS) is more and more often replaced by blackheart malleable cast iron (GJMB) with its specific cost advantages. GJMB is easier to cast and to machine due to a sulfur content of 0.17 %, which is 8-10 times higher than in GJS. However, that sulfur content is challenging in terms of hot-crack formation during conventional CO₂ laser welding using nickel containing wire filler. Such hot-cracks are due to low melting point iron sulfides and have to be avoided.

Another important aspect when welding cast materials is the general desire to reduce manufacturing costs. This is possible due to further developed laser sources, but also based on stable, energy efficient and resource sparing welding processes. It is also possible to save costs by optimizing component designs. However, detailed design specifications are scarce for axially and torsionally loaded joints. Thus to obtain them is the subject of current Fraunhofer IWS research.

OUR SOLUTION

Fraunhofer IWS engineers together with partners from the automotive industry have developed a very competent and reliable laser welding process for the crack-free joining of blackheart malleable cast iron (GJMB) with case hardened steel (Fig. 3).

The process is performed with a modern disk laser of advantageous beam quality. The resulting seam flanks are mostly parallel (Fig. 1). Laser power, welding speed and relative welding position are adjusted to achieve mixing ratios in the melting zone, which lead to cooling and solidification conditions that effectively suppress the formation of hot-cracks. The mixing ratio is adjusted via the relative beam position with respect to the weld gap. A special beam guiding optics achieves a reliable adjustment with the precision of a few hundreds of a millimeter.

The very high welding speeds have another useful side effect. Due to the speed no crack sensitive microstructure, such as extremely hard ledeburite, can form in the heat-affected zone of the cast material. There is also very little energy deposited into the welded parts. This causes few thermal transient stresses and deformations. An additional nickel containing wire or sheet material is not required anymore. This substantially adds to the cost savings.

RESULTS

The welding process was tested for a number of GJMB and case hardened steel sample parts. It was possible to achieve high quality GJS/GJMB welds with nearly parallel seam flanks



while using substantially reduced laser powers and energy inputs compared to previous processes. Nickel additives were not necessary.

The melting zone consists of the desired retained austenitic structure with its advantageous ductile properties (Fig. 3). Only very few hot-cracks form in spite of the very high sulfur content in GJMB. Their form is drastically reduced compared to conventional laser welding processes. Ledeburite can only be found in small quantities in the form of islands in the heat-affected zone.

The results also show that mixed joints involving case hardened steel and GJMB or GJS can be welded with mostly similar parameters when using disk lasers. A typical laser welding task for a differential gear box involves a welding diameter of about 150 mm and a welding depth of about 5.0 mm. When using the disk laser the energy input is only about 25% and thus substantially lower compared to previously established CO₂ laser welding processes with filler material.

The cyclic load carrying capacity of disk laser welded parts was evaluated at Fraunhofer IWS using a servo hydraulic axial-torsional testing machine (Fig. 4). The purpose was to obtain design specifications for component optimization. The test specimens were loaded according to von Mises' distortion energy stress hypothesis. The typical loading case for a weld seam in a differential gearbox is a combination of bending and torsion.

A GJMB/case hardened steel mixed joint is achieved as high load carrying capacities as GJS/case hardened steel joints when welded with disk lasers. The results significantly exceeded those of GJS/case hardened steel joints typical in the

automotive industry, which are welded with conventional CO₂ lasers and filler material.

Currently the systems are tested for vibrational fatigue strength. Preliminary results are already giving hope that there will be additional cost savings potential through adjusting the weld penetration depth to the required loads.

- 1 *Welded mixed joint from GJMB/case hardened steel (overview)*
- 2 *Weld material structure of the mixed joint from GJMB/case hardened steel*
- 3 *Laser welding of a test sample made from GJMB/case hardened steel*
- 4 *Long-term vibrational fatigue testing of a test specimen in a servo hydraulic axial-torsional testing machine*

CONTACT

Dipl.-Ing. Uwe Stamm
 phone.: +49 351 83391-3152
 uwe.stamm@iws.fraunhofer.de





AUTOMATED LASER BEAM WELDING OF TUBE/TUBE SHEET JOINTS

THE TASK

Heat exchangers cool liquids in various industrial machines. Spatial separation of primary and secondary media makes it possible to make use of the waste heat, which contributes to the efficient utilization of energy resources. However, manufacturing heat exchangers is a time and energy consuming process.

Welding of tube/tube sheet joints can be performed with a special TIG weld head centered in the tube by a pin. The head then welds with a rotating electrode. Over the years this technology has proved to be very reliable. The process is stable and not likely to be disturbed by outside influences due to the solid connection between weld head and workpiece. However, the process is also characterized by high heat input and slow speed yielding to thermal warpage and long process times.

The task is therefore to reduce time and energy consumption during the manufacturing of tube/tube sheet joints. Furthermore, an automated processing is desired for which laser beam welding is principally suitable.

successfully demonstrated. However, the industrial implementation has so far failed due to insufficient process robustness under actual production conditions.

An international consortium with project partners AIMEN Technology Center, Labor, CMF, ENSA, Fraunhofer IWS, Integasa, Precigal, Precitec and Sill Optics have now successfully implemented a laser welding process based on the TIG welder concept. An industrial robot now automatically moves the weld head from one welding location to the next, which was previously done by hand.

Development and testing of the laser weld head for tube/tube sheet joints was funded by the European Union under the program "Orbital" (FP7 262455). Fraunhofer IWS engineers developed the opto-mechanical concept, which determines the required welding path with respect to the axially located centering pin. The system was tested and validated.

OUR SOLUTION

The laser welding of tube/tube sheet joints was already

Weld head parameters

Laser type	fiber coupled solid-state laser
Wavelength	1030 - 1090 nm
Fiber coupler	QBH, D-connector
Maximum laser power	2000 W
Maximum welding speed	5 m min ⁻¹
Industrial robot	KUKA, ABB, other models upon request

2



RESULTS

The welds should be fabricated in a fully automated manner (Fig. 2). The geometry of the tube sheet is given in form of CAD data. A post processor creates the motion program for the robot. Measurement routines are provided for each robot to define the coordinate system.

a materials point of view, tube/tube sheet joints were made from Inconel, stainless steel and titanium (Fig. 3). Complying with customer requests, the weld seam geometries correspond precisely to those of TIG seams.

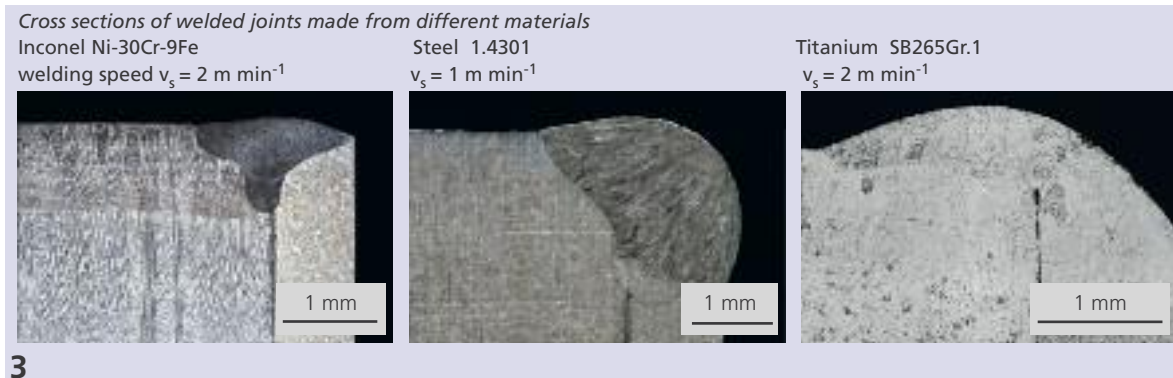

The software user interface allows the adjustment of individual laser welding parameters or to select already established parameter sets.

An automatic mode can be activated, which will perform a fully automated welding of the tube sheet. A manual mode is available for testing purposes and to evaluate the effect of weld parameters. A laser protection class 1 certification has been applied for.

Compared to the conventional TIG process, the laser welding process requires one tenth of the time. The automated laser process also decreases auxiliary process times, which reduces the total fabrication time even further. Only a fraction of the time is needed compared to the conventional process. From

- 1 *Titanium welding process of a tube/tube sheet joint*
- 2 *Laser weld head for tube/tube sheet joints*

CONTACT

Dipl.-Ing. Patrick Herwig
 phone: +49 351 83391-3199
 patrick.herwig@iws.fraunhofer.de



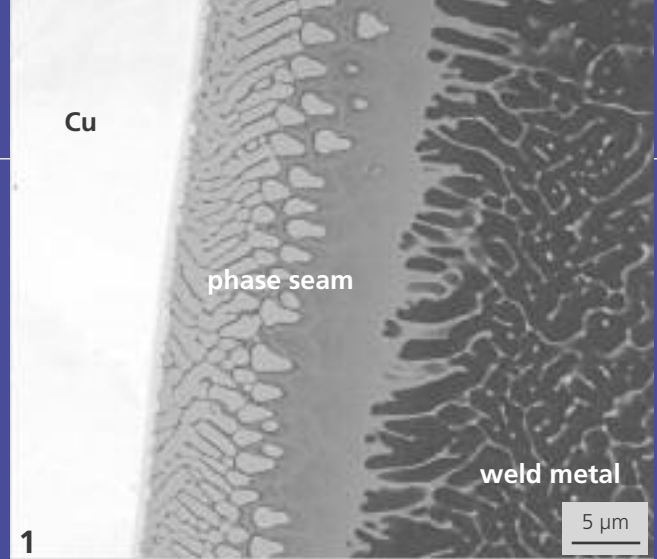

STRUCTURAL ANALYSIS OF AL-CU JOINTS FOR ELECTROMOBILITY

THE TASK

Battery modules are assembled from individual battery cells. An important step is the wiring of these cells with high current cell interconnectors. Currently, mechanical screwing is the standard method to assemble the interconnectors implying disadvantages with respect to costs and reliability. The task is therefore to develop functionally integrated high current interconnectors using cost optimized fabrication technologies to replace conventional screwing solutions.

Such interconnectors require joining aluminum and copper to connect battery cells. Dissimilar metal joints, however, face numerous fabrication challenges such as the formation of brittle intermetallic phases, the formation of microcracks and also contact corrosion. Characterizing the zones and phases found in such joints is a very critical and essential step when developing reliable fabrication processes for series production. The goal is to obtain a thorough understanding of how process parameters affect the resulting structures and to predict the mechanical and electrical reliability of the Al-Cu joints.

Joining aluminum with copper requires new welding strategies since both materials have limited mutual solubility and their melting temperatures, thermal conductivities, heat capacities and coefficients of thermal expansion are also significantly differing from each other. Conventional welding leads to massive formation of very brittle intermetallic phases, which drastically limit the mechanical strength of the joint. Laser and electron beam welding processes can reduce the amount of intermetallic phases but not sufficiently enough to achieve a subcritical level.

OUR SOLUTION

As part of the BMWi funded ELEKTRO POWER initiative the Fraunhofer IWS participates in a collaborative research project titled BatCon. Jointly with industry partners Robert Bosch GmbH, ElringKlinger AG and Wieland-Werke AG, IWS engineers develop novel high current interconnectors for battery modules and systems based on cost optimized manufacturing technologies. IWS provides know-how to test innovative joining technologies such as laser induction roll plating, friction stir welding and electromagnetic pulse welding. Such processes are explored for joining materials that are difficult to weld based on melting. The most suitable process needs to be identified to reproducibly and efficiently produce reliable Al-Cu cell interconnectors.

Another focus of the BMWi project is to research the basic mechanisms when joining aluminum with copper. The goal is to optimize the joint properties and part design to best match the application requirements. The performance of this task relies on competences in materials analysis. Special know-how exists in metallographic preparation techniques and expertise in executing and interpreting high and highest resolving electron microscopy and X-ray microanalysis.

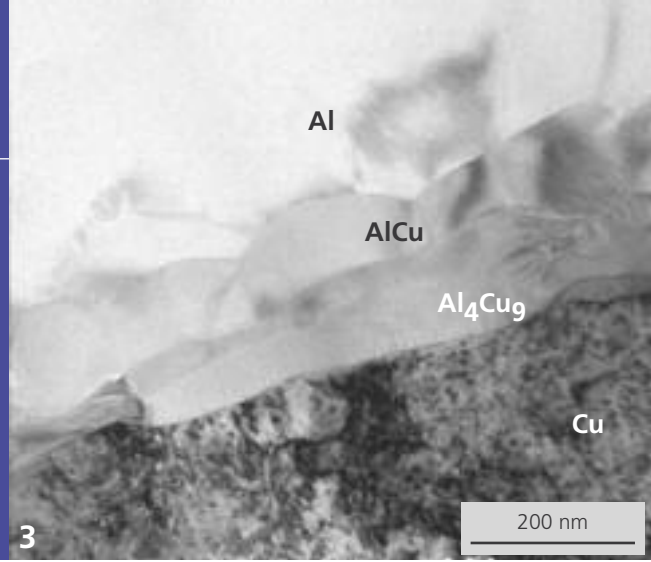

RESULTS

Fraunhofer IWS engineers successfully produced Al-Cu joints by laser beam welding, friction stir welding, laser induction roll plating and electromagnetic pulse welding.

Laser beam welding was successfully producing I-joints but only for very thin sheets of up to about 1 mm in thickness. For thicker sheets it was impossible to reduce the phase seam thickness below 10 μm even when using a brilliant laser in the kW range (Fig. 1). This reduces the mixed joint's strength and ductility, which limits the use of laser welding as a fabrication processes for thicker sheets. Friction stir welding, laser induction roll plating and electromagnetic pulse welding all achieve subcritical phase seam thickness of less than 1 μm . Mechanical tests showed failure modes breaking the aluminum base material and not the joint. The low phase seam thickness is also beneficially reducing the contact resistance, which was much lower for these three techniques when compared to laser welding and conventional screw connections. TEM analysis provided additional valuable information about the growth process and type of the forming phases (Fig. 3).

So far the project results also show that the quality of Al-Cu mixed joints will depend strongly on the mechanical properties of the used alloys, the geometric dimensions and the choice of seam configuration. For example, higher strength aluminum alloys are preferred to pure aluminum for friction stir welding. Friction stir welding I-joints of aluminum and copper leads to substantial mixing of the materials, which can be avoided in certain overlapping configurations. Similarly the electromagnetic pulse welding technology is more effective in partially overlapping joint geometries. Process technology

challenges occur when trying to weld parts of non-rotational geometry. An open question from a materials science standpoint is how process instabilities leading to local melting of the material could affect the results.

Today it is possible to laser induction roll plate completely overlapping strips of Al and Cu at high quality (Fig. 2). The strip width can be up to 22 mm. The next big challenge in the BatCon project is to further develop this process to make partially overlapping joints. Such a configuration would be best suited for the cost effective fabrication of bimetal cell connectors. The laser induction roll plating is the favored process for joining copper and aluminum from both, the manufacturing and the materials viewpoints. The process has two independent heat sources at its disposal: laser heating and induction heating. These heat sources are applied to adjust the different plastic behaviors of the metals at room temperature to achieve an optimized joint quality. The process is very flexible with respect to the usable Cu and Al alloys.

- 1 SEM image of a laser weld seam phase seam
- 2 Completely overlapping and plated Al-Cu bimetal
- 3 SEM image of the phase seam formed during laser induction roll plating

CONTACT

Dr. Jörg Kaspar
 phone: +49 351 83391-3216
 joerg.kaspar@iws.fraunhofer.de



VACUUM SUCTION BLASTING AS AN EFFECTIVE SURFACE CONDITIONING METHOD FOR ADHESIVE BONDING

THE TASK

Sandblasting (pressure blasting) is an efficient method to prepare surfaces for adhesive bonding. The process cleans as well as structures the substrate surface. In addition, it is possible to deposit an adhesion promoting silicate film when used with alkoxy silane modified blasting abrasives (SACO®).

However, the process is also suffering from a number of disadvantages in particular with respect to new application fields. This includes, for example, the development of dust, the strong abrasive effect and the poor inline compatibility of the blasting process. The surface treatment is also inhomogeneous due to the non-uniform jet profile coming out of the nozzle. Fraunhofer IWS engineers took on the task to

solve these issues by utilizing the process of vacuum suction blasting.

OUR SOLUTION

During coating depositing suction blasting the blasting abrasives is accelerated exclusively due to the evacuation of a steel jet cap, which is sealed to the substrate (Fig. 1). The abrasives are pumped out immediately after interacting with the substrate. The process operates practically dust free and is very selective. No additional encasements or chambers are required. The jet cap as a tool is moved across the substrate surface. Pressure blasting unavoidably causes an expansion of the mixture of carrier gas and abrasive upon exiting the nozzle. This is not the case here, since vacuum suction blasting creates a nearly homogeneous jet profile and thus a uniform impact velocity of the jet particles. Consequently the desired processing result can be adjusted very precisely.

The experimental machine installed at the Fraunhofer IWS Dresden is fully automated (Fig. 2). It is built around a 6-axes industrial robot. This provides enormous flexibility with respect to treatable part geometries. The process was further improved by adding a gravimetric controller to regulate the abrasive throughput. This improved process stability and material efficiency.

Due to the high precision, it is possible to remove materials with submicrometer accuracy. Therefore the process is suitable to treat fiber-reinforced polymers without damaging fibers. Thin film coated substrates can be treated without breaking through the coating.

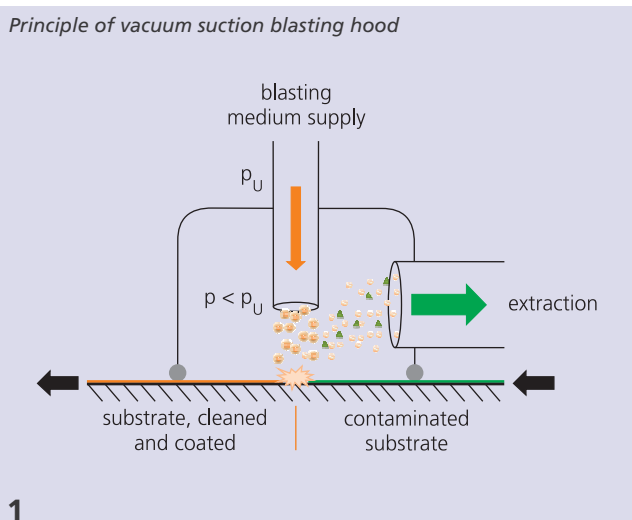



RESULTS

The process was applied to prepare the surfaces of dip-galvanized steel parts for adhesive bonding with plastics. The resulting was a 15 MPa increase of the shear strength of the bond. A single process step was applied to clean, structure and coat the substrates. The gentle process only minimally removed the zinc layer.

Due to its gentle surface interaction, vacuum suction blasting is suitable for treating thermally and mechanically sensitive materials. The process is especially advantageous when treating surfaces of plastics, GRP, CFRP, metals such as steel, titanium and magnesium as well as glass. Vacuum suction blasting is used to prepare surfaces prior for joining, coating and painting processes in fully automated or manual manufacturing lines.

Scanning electron microscopic cross section of the coating design of dip-galvanized steels after vacuum suction blasting

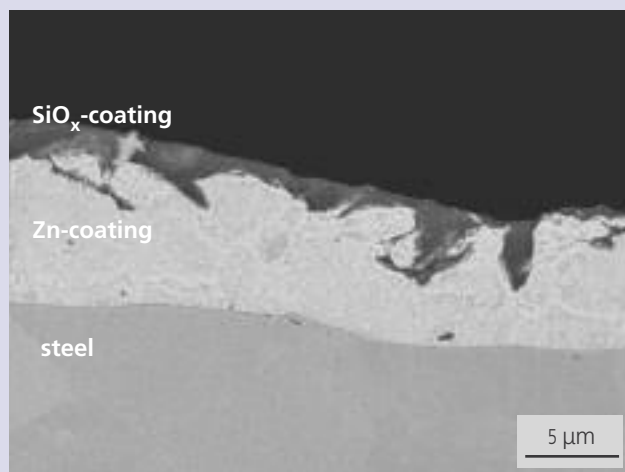

Topographies of treated surfaces
top – SACO®-vacuum suction blasting
bottom – SACO®-pressure blasting

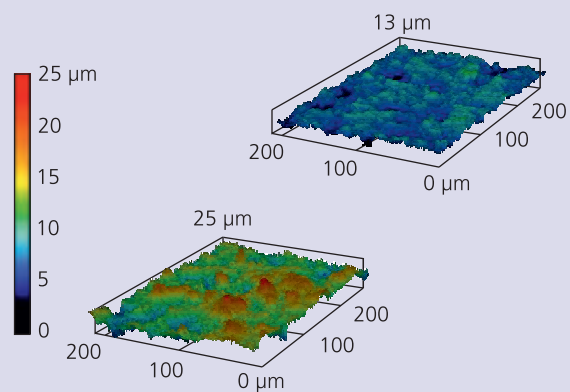

Potential scratches in the zinc coating are filled with the silicate coating (Fig. 3). The corrosion protective function of the zinc coating remains in full effect. The effective surface area required for adhesive bonding increases many times. The surface is more finely structured compared to pressure blasting results (Fig. 4).

Fraunhofer IWS engineers cooperate with experienced equipment manufacturers to build systems. This simplifies the process integration into the manufacturing lines of IWS' industry customers.

2 Vacuum suction blasting system, treatment of galvanized steel sheets

CONTACT

Dr. Irene Jansen
phone.: +49 351 463 35210
irene.jansen@iws.fraunhofer.de



HEAD OF DEPARTMENT DR. ANDREAS WETZIG





"First do what is necessary, then what is possible and soon you will manage the impossible."

Franz von Assisi

BUSINESS FIELD ABLATION AND CUTTING

Editor: In recent years your department performed various research projects to improve the dynamics of laser processing and is reaching speeds near the technological limits. How does this look in practice?

Dr. Wetzig: We have been successfully implementing our ideas. Some of the projects are of a proprietary nature so that we cannot discuss them here. However, we installed two industrial cutting solutions. A manufacturer of punching and bending parts is now manufacturing parts using the IWS developed highly dynamic form cutter (HDFC). Preliminary series production is being evaluated applying HDFC technology at a customer plant in the automotive industry. The same customer is also using laser remote cutting of punching and bending parts of sheet thicknesses up to 0.5 mm.

Editor: What is new in microstructuring?

Dr. Wetzig: In addition to classic laser micromachining, we have continuously been working on a direct laser interference structuring process, which is meanwhile ready for industrial use. The specialty of this process is its capability of applying submicron structures periodically and swiftly across a larger surface area. There is no other laser micromachining process that can match the speed of direct laser interference structuring. This provides us with a unique selling feature.

Editor: Are there any industrial implementations of this technology?

Dr. Wetzig: Not quite yet. A first step was the successful acquisition of publicly funded projects to provide external support for the continuation of the development. However, we have performed numerous feasibility studies of direct laser interference structuring for customers in many industries from mechanical engineering to medical devices. Selected projects show promise, and so we expect first industrial installations to occur within two years.

Editor: Your department works on a broad area of topics. Surely there must be more research results worth pointing out?

Dr. Wetzig: Yes indeed, here are two examples. We received the "Dorothy Hegarty Award 2012" by the journal ATLA for one of our papers discussing lab-on-a chip biosystems technology, which was greatly appreciated. Another example is our collaboration with the Paul Scherer Institute in Switzerland. With a neutron radiation experiment we were able to prove changes of the magnetic domain structure in materials caused by laser processing. This is not only of scientific significance, but also of practical value to all industrial users of soft magnetic materials.

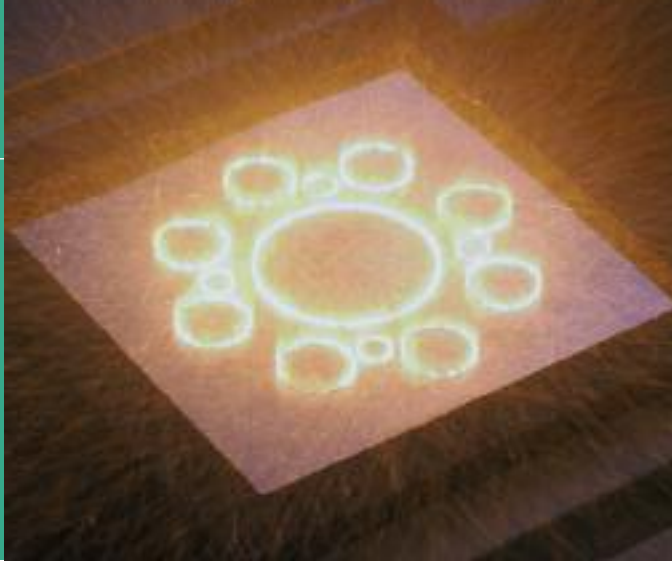

COMPETENCES

HIGH SPEED LASER PROCESSING

Research addresses developing process and system technologies for high-speed applications. A detailed process understanding is the basis for the successful industrial implementation of the technology. Our solutions offer the highest processing speeds. The spectrum includes remote welding, cutting and surface treatment processes for metals and non-metals. It also covers the development, setup and qualification of highly dynamic processing systems. A wide range of scanner system technology is available, which is partially in-house developed and can be customized to meet the needs of our clients.

CUTTING

The group focuses on process development in the field of laser fusion cutting. Topics include, for example, the improvement of the cutting quality with solid-state lasers or the optimization of electro metal sheet laser cutting without affecting the magnetic properties of the material. Another area is the qualification of novel cutting processes such as the remote laser cutting for manufacturing integration. Lasers of various wavelengths, powers and beam qualities are available. The processing results are characterized including roughness measurements at the cutting edge and detailed texture analysis in the vicinity of the cut using SEM and TEM.

MICROPROCESSING

An extensive and modern equipment pool and the associated know-how enable us to perform research for laser beam microprocessing applications. The purpose is the miniaturization of functional elements used for the design of machines, plants, vehicles and instruments as well as in biological and medical products. The group generates micron structures in polymers, metals, ceramics and biocompatible materials. Technology platforms are developed in the field of biosystems technology. Lab-on-a-Chip systems with integrated micropumps are used to perform complex cell culture experiments for medical diagnostics and substance testing. These experiments can copy actual processes in living organisms.

SURFACE FUNCTIONALIZATION

The group fabricates 2- and 3-dimensional micro- and nanostructures on polymers, metals and ceramics and coatings. New methods generate structures spanning macroscopic dimensions and yet provide micro- and nanoscopic properties over large areas. In addition to modifying topographies, it is also possible to periodically change the electrical, chemical and mechanical properties. Such structured surfaces can be used in biotechnology, photonics and tribology. The group is also developing system concepts for large area processing including the required processing heads.



GROUP LEADER HIGH SPEED LASER PROCESSING

DR. JAN HAUPTMANN

phone +49 351 83391-3236
jan.hauptmann@iws.fraunhofer.de



HEAD OF DEPARTMENT

DR. ANDREAS WETZIG

phone +49 351 83391-3229
andreas.wetzig@iws.fraunhofer.de



GROUP LEADER CUTTING

DR. ANDREAS WETZIG

phone +49 351 83391-3229
andreas.wetzig@iws.fraunhofer.de



2013 PROJECT EXAMPLES

1. Systems technology for highly dynamic beam scanning 90
2. Time-resolved characterization of laser optics 92
3. Process characterization during laser beam fusion cutting 94
4. Property characterization of laser processed fiber composites 96
5. Laser structuring to generate interference color effects 98
6. Generation of hollow fibers for bioreactor systems by 2 photon polymerization 100
7. Pinpoint dosage and detection in Lab-on-a-Chip systems 102

GROUP LEADER MICROPROCESSING

DR. UDO KLOTZBACH

phone +49 351 83391-3252
udo.klotzbach@iws.fraunhofer.de



GROUP LEADER SURFACE FUNCTIONALIZATION

PROF. ANDRÉS-FABIÁN LASAGNI

phone +49 351 83391-3007
andres-fabian.lasagni@iws.fraunhofer.de





1



2

SYSTEMS TECHNOLOGY FOR HIGHLY DYNAMIC BEAM SCANNING

THE TASK

Only a decade ago, scanning systems were exclusively used for marking tasks with pulsed lasers. Today it is possible to deflect 6 kW cw power laser beams with galvanometer driven tilting mirrors. Scanner technology today is applied for laser beam welding, sublimation cutting of metals, textiles and composite materials and to dynamically shape the beam for laser surface refinement.

Suitable system technology has to meet different technical requirements. There are numerous possibilities to design a system and also many system builders. The selection of the best solution is often difficult for the user. Fraunhofer engineers therefore endeavored to classify the processing systems based on scientific considerations.

OUR SOLUTION

Highly dynamic axes systems for kW laser radiation have a different optics design. There are differentiations between pre-objective and post-objective scanning. The focus diameter is relevant for the process and is determined by the beam quality of the laser, the beam aperture and the focal length of the optical system.

The size of the processing field and the working distance to the focal plane are also characteristic parameters. The latter defines besides the mirror mass also the dynamic properties of the beam spot on the part. Commercially available systems achieve processing speeds of up to 20 m s^{-1} . However, scanner systems are limited with respect to maximum dynamics.

To compare processing systems technical specifications can be used. It is also important however, to consider type and flexibility of the axes control systems, which are critical to whether or not a system can be used for a particular application. Fraunhofer engineers developed measurement routines to compare the dynamics of different scanner systems. Dynamic behavior, characterized by positioning deviations are quantified based on reference contours (Fig. 3 and 6).

In the most simple case target and actual position data are compared.

If the system does not provide external positioning information reference engravings are measured using fast pulsed lasers. The dynamic behavior during harmonic oscillations is characterized with amplitude-frequency dependencies (Bode diagram). To compare beam scanner

X-Y-plot during generation of a 90° corner with target speed of $v = 15 \text{ m s}^{-1}$

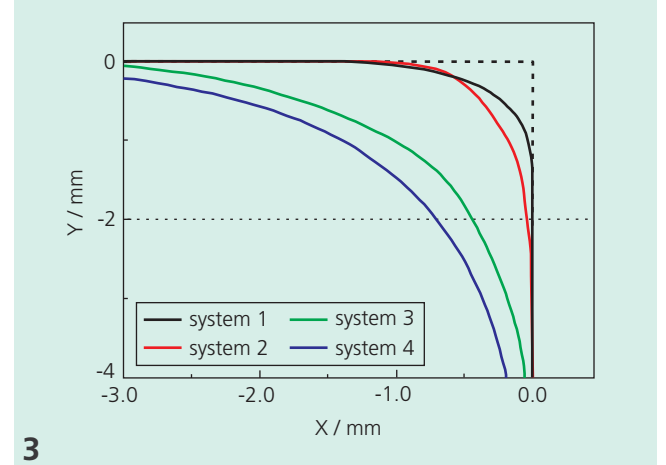

3

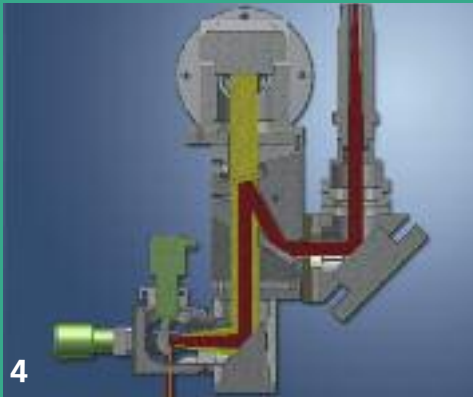

systems from different manufacturers, it was also necessary to develop a family of control modules for using each of the systems.

RESULTS

Galvanometer scanners were used for laser macro materials processing and the gained experience provided input for implementing a database. The database holds technical specifications of beam scanners that are commercially available and also those that are used at IWS. The database user can call upon additional modules to calculate achievable spot diameters and intensities when using lasers of different beam qualities.

If data is available such as processing field dimensions, spot diameter and dynamics, the user has the tools to design the ideal scanner system based on this information. Criteria can be

weighted to derive recommended solutions from the pool of commercially available systems. In some cases the recommendation will be to use a very special optics design. For such applications our high-speed laser-processing group has an excellent track record of successful industry projects to develop application adapted scanner systems.

- 1/2 1D laser scanner optics with scanner-position-dependent laser power modulation: Implementation and principle
- 4/5 Multi wavelength optics to process composites: principle and implementation

Contour deviation when generating a 90° corner with different scanner systems

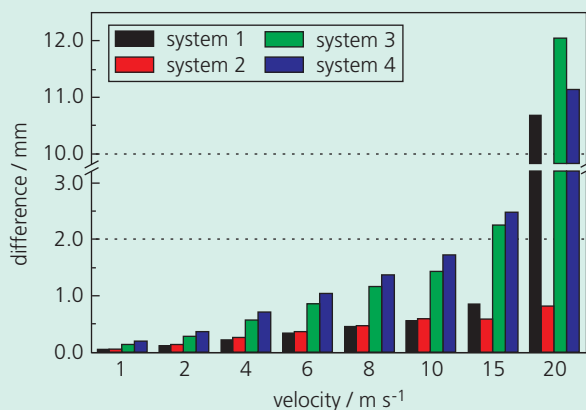

6

CONTACT

Dipl.-Ing. Annett Klotzbach
 phone: +49 351 83391-3235
 annett.klotzbach@iws.fraunhofer.de



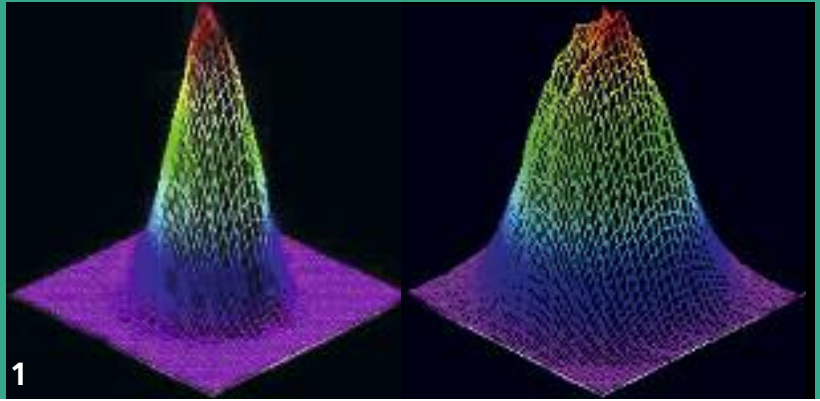

TIME-RESOLVED CHARACTERIZATION OF LASER OPTICS

THE TASK

The “laser as a tool” is always a combination of the beam source, the beam guiding system and the processing optics. To achieve excellent processing results, the optics needs to maintain the beam quality coming from the laser and also shape that beam according to the processing requirements. Diffraction limited beam sources are available up to 10 kW and in lower order ranges up to 100 kW. Such power ranges drive the transmitting optics to thermal limitations for stable beam shaping. This is a challenge for manufacturers of laser optics as well as the laser users. It requires the exact determination of the actual situation and also the reproducible demonstration of optimizations with respect to substrate materials, coatings and shaping capabilities of the elements.

Laser beam diagnostics is a common method to characterize optical imaging parameters of laser beam sources and optics. Three-dimensional intensity distributions are measured within the working spot of the laser beam. Changes of optical imaging parameters can be determined, resulting from the interaction of laser and optics.

A measurement technique that detects the aberrations of a single optical element but is decoupled from nearby elements and the laser beam, would benefit the development of beam shaping optics. The time-resolved characterizations, the clear allocation of aberrations since absorption, heating and changing refractive indices are the most important factors that lead to shifting focal points. In particular during laser startup such gradients are significantly non-stationary due to heat conduction and cooling.

OUR SOLUTION

Fraunhofer IWS engineers developed a measurement setup based on the wavefront sensor designed by Hartmann and Shack. This setup captures the wave front curvature, which displays various aberrations in time-resolved form.

The hardware includes a CCD camera and a lens array. It is modular and can be adapted to the desired measurement frequency. Data are generated by software from the recorded changes in the measurement array. CCD sensors can only be exposed to a few microwatts. Therefore a special low power measurement beam is used at a different wavelength. Additional components include dichroitic beam splitters and reflective bandpass filters. The system can be used to measure processing optics or their individual components decoupled from other influences.

Typical measurement results are the temporal changes of focal length and spherical aberrations but also high order aberrations depending on the requirements. The measurement setup can also be changed to measure mirror optics.

RESULTS

A unique feature of the new measurement method is its capability to determine the imaging behavior with any temporal resolution. It is also possible to evaluate individual components of the imaging system.

Figure 4 compares the shift in focus for lens systems made from different materials as it is conventionally done. Judging

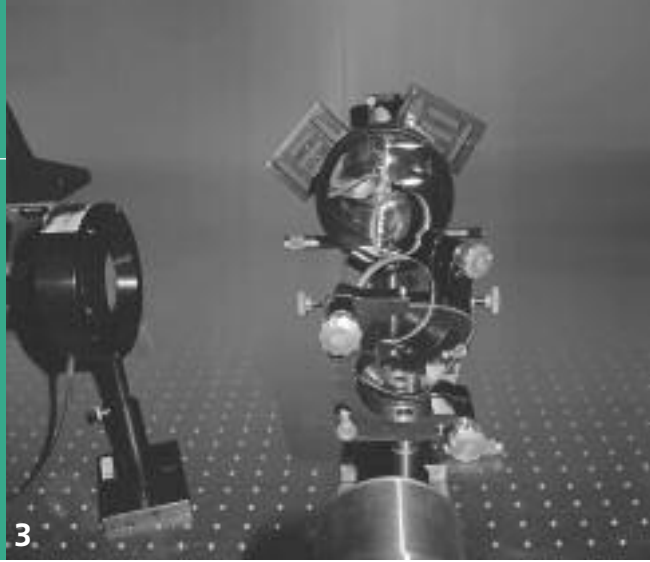
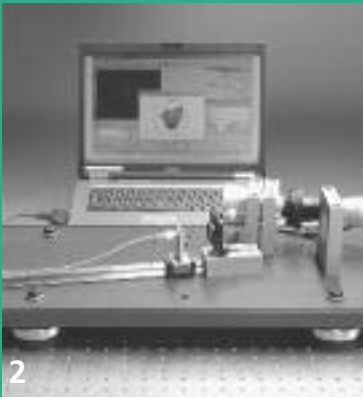

the performance of a processing optics (e.g. for remote cutting) is possible but with limitations. The time-resolved analysis of the quartz glass optics shown in Figure 5 provides more process relevant information for every moment of the process.

It is also possible to simulate complex processing regimes. The simulation predicts and estimates the changes of the optical imaging system. Limiting the process to individual lenses also helps to compare the effect of different coatings and materials to optimize optical systems. Knowing thermal time constants

Laser induced focus shift of imaging optics different substrate materials

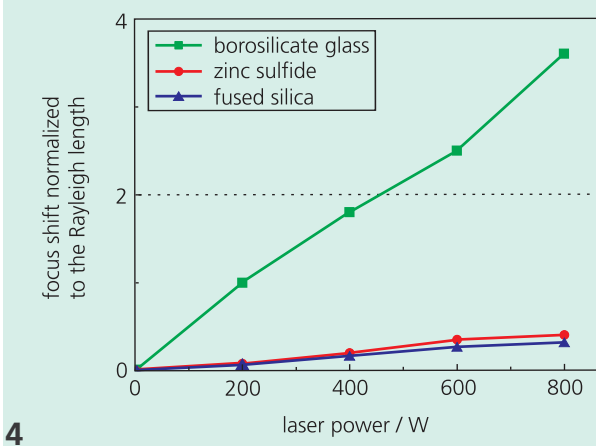

is useful for process development and leads to increased process stabilities. The new measurement setup in combination with many lasers for materials processing and beam diagnostics systems is very useful to Fraunhofer IWS engineers who evaluate and validate new lens substrates, coatings and complete processing optics. A database for mostly commercial systems is available at IWS to provide comprehensive and independent consultation to our customers.

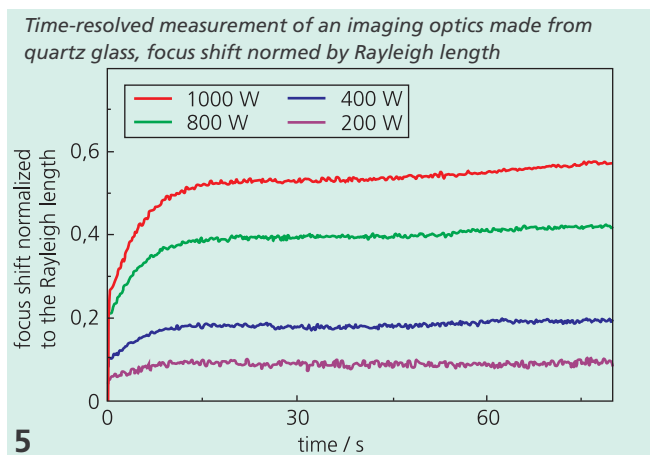

- 1 Intensity distribution in the focal plane of a focusing optics
- 2 Wavefront sensor measurement setup to measure transmitting individual elements
- 3 Experimental set up of a wave front sensor

CONTACT

Dipl.-Ing. Patrick Herwig
 phone +49 351 83391-3199
 patrick.herwig@iws.fraunhofer.de



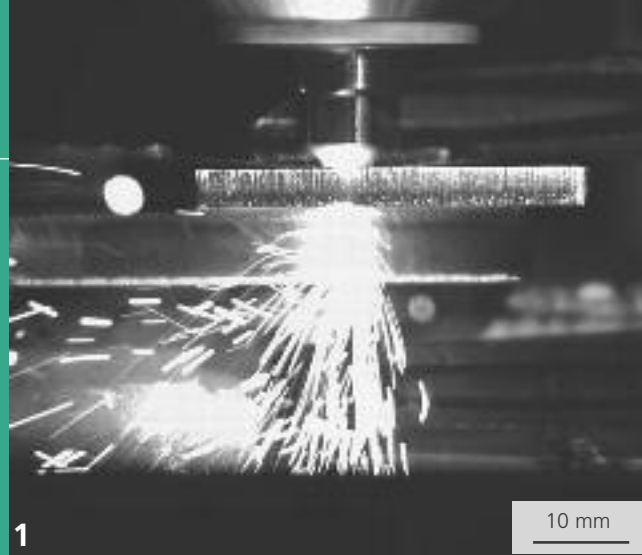

PROCESS CHARACTERIZATION DURING LASER BEAM FUSION CUTTING

THE TASK

Laser beam fusion cutting is a widely used process, for example, to cut metals. Compared to CO₂ lasers, the process sequence changes when using solid-state lasers. The continuing use of CO₂ process control systems is at best possible with limitations. This fact creates challenges for fully automated production processes and quality management systems.

It would be desirable to reject parts based on different criteria. An example is a complete process stop leading to an incompletely cut part, which is then useless for subsequent processing steps. But also a partially reduced cutting edge quality may already be reason for rejection. Automatically filtering out scrap parts requires monitoring of the cutting process and predicting the cut quality. Ideally this monitoring would be linked directly to the process to provide the opportunity to quickly and effectively correct the cut quality.

Designing such an intelligent cutting process requires a deep process understanding and knowledge about useful criteria to judge the current process state. Therefore the task is to develop suitable methods to reliably detect different process states. Such methods have to be fast, robust and adapted to the special circumstances of laser beam cutting processes.

OUR SOLUTION

Theoretically different methods are available to observe the process. The most practical solution appears to be systems that can be placed coaxially inside the optical beam path.

Sensors can be used to record the emitted process light. For some basic considerations other techniques can be used as well.

One approach is to analyze the melt ejected from the kerf. Different characteristics are observed depending on the state of the cutting process and the resulting edge quality. In collaboration with the Technische Universität Dresden, Fraunhofer researchers applied particle image velocimetry (PIV) to high-speed images of ejecting melt. Clear correlations were identified between the resulting edge quality and the ejection direction, velocity and local particle distribution of the melt.

Another approach is the coaxial observation and analysis of the emitted process light. A spectral analysis can reveal whether a cutting process is stable or not. It is well known that when cutting with CO₂ lasers, the process is massively affected when plasma forms. Whether or not such effects are also occurring when cutting with solid-state lasers can be determined by using spectrometers.

RESULTS

Many experiments were performed with varying methodologies. The previously described investigations were initial experiments to obtain detailed process knowledge. The required equipment is very complex and the data analysis cannot be performed in real-time during the process. Therefore the performance of such experiments was limited to the laboratory environment.

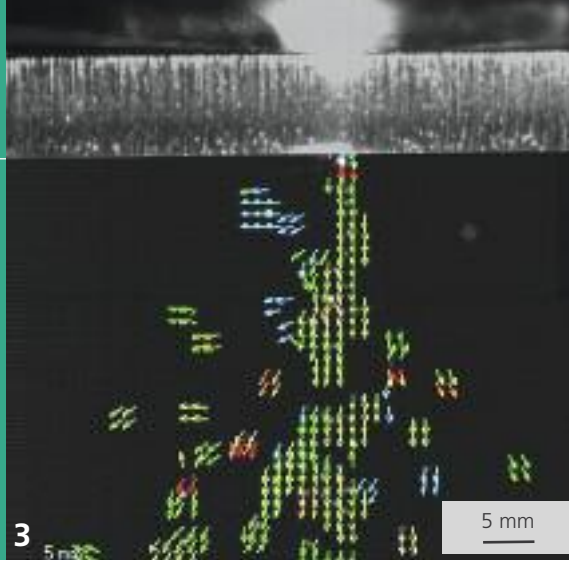
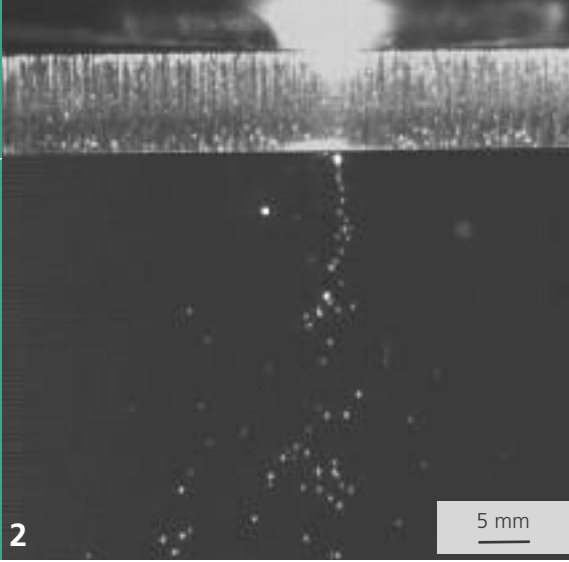

The results are useful to check the outcome of simulations. They also form the basis for implement systems that can be deployed in industry. In such environments it makes sense to use photo diodes. A spectrally resolved analysis is not necessarily required.

Generally the methods investigated were shown as capable of providing information about the processes. Catching a complete process stop is comparatively simple. However, identifying declining cut quality is still difficult. First identifying whether or not the process is in a stable state is a step in the right direction. If not, it usually results in poor cutting quality. The attribution of the process to stable and unstable categories was possible by analyzing the process light as well as applying PIV analysis.

To obtain more detailed information about the process state, it is necessary to further refine detection and signal analysis methods. It is, however, expected that the discussed methods will ultimately be used for process and quality control of cutting processes. Applications include microprocessing (e.g. fine cutting) as well as macro processing (e.g. classic fusion cutting).

- 1 Overview image of melt ejection
- 2 High-speed image
- 3 PIV analysis

Spectra of unstable (red) and stable (green) cutting processes using a 4 kW fiber laser (steel substrate X5CrNi18-10, thickness 12 mm)

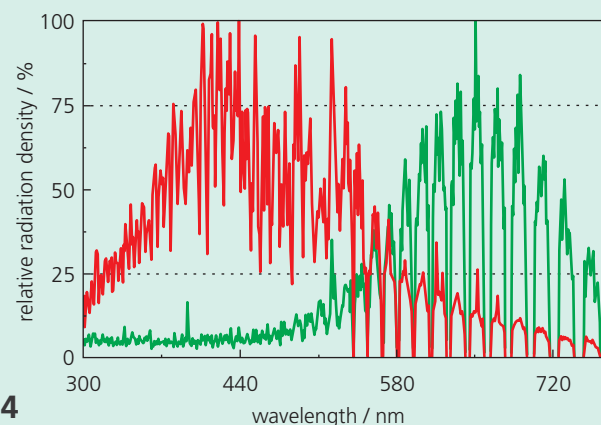

CONTACT

Dipl.-Ing. Thomas Pinder
 phone +49 351 83391-3202
 thomas.pinder@iws.fraunhofer.de





PROPERTY CHARACTERIZATION OF LASER PROCESSED FIBER COMPOSITES

THE TASK

Not only the automotive and aerospace industries, but also classic mechanical engineering is aiming at using more components made from fiber reinforced plastics (FRP). FRP properties are utilized to make highly precise and lightweight parts with high specific stiffness. The low coefficient of expansion of carbon fibers (CF) is often advantageous.

The greatest challenge is to improve and optimize existing production processes, which, among others, is being addressed with laser technologies among others. Ensuring the reproducibility of developed process technologies requires a high level of understanding of laser-material interactions. This includes knowledge about material properties and their changes due to laser treatment.

FRP consists of many single layers, which in their entirety determine the material behavior. Laser radiation caused thermal effects in a single layer may affect the entire composite. When laser processing FRP, it must be considered that heat might penetrate into the components due to the anisotropic properties of the composite material.

Undesired damages include the destruction of the matrix material, the exposure of individual fibers, exceeding the glass transition temperature of the matrix material and the destruction of the sizing on the fibers. In most cases such defects reduce the adherence between fiber and matrix.

The fiber fracture caused by reduced fiber matrix adherence is the critical failure mode for FRP component strength. The task is to find a testing method that reduces the failure of test specimen to fiber fracture.

OUR SOLUTION

The Fraunhofer IWS solution is a tensile test method with test specimens which limits the material damage to the failure mode of fiber fracture.

The test specimens have a unidirectional layer structure with fibers oriented perpendicular to the direction of tension. Fig. 1 (right) shows a test sample made from carbon fiber reinforced epoxy with a centrally located sacrificial laminate. During the remote laser cutting process, heat is transferred into the test sample. This causes matrix withdrawal and changes the fiber matrix adherence without changing the sample's geometry. Such thermal impact will then reduce the load carrying cross sectional area and thus affects the tension at which the test specimen ultimately fails.

A 5 kW high power fiber laser with high brilliance was used as a beam source to cut the sacrificial laminate. Modified parameters were intensity and deposited linear energy density.

RESULTS

A tensile tester (Fig. 2) was used to load the test sample to the point of fracture ($F_{max} = 50$ kN). Measuring the initial cross section of the sample makes it possible to predict required fracture tension. Fig. 3 plots the fracture tension versus the deposited linear energy density for the two carbon fiber types HT (high tenacity) and HM (high modulus).

The investigations proved that this experimental setup is suitable to quantify the influence of laser processing on the strength of the composite materials. The error bars in the plot mark a 95% confidence interval, i.e. the range in which 95%

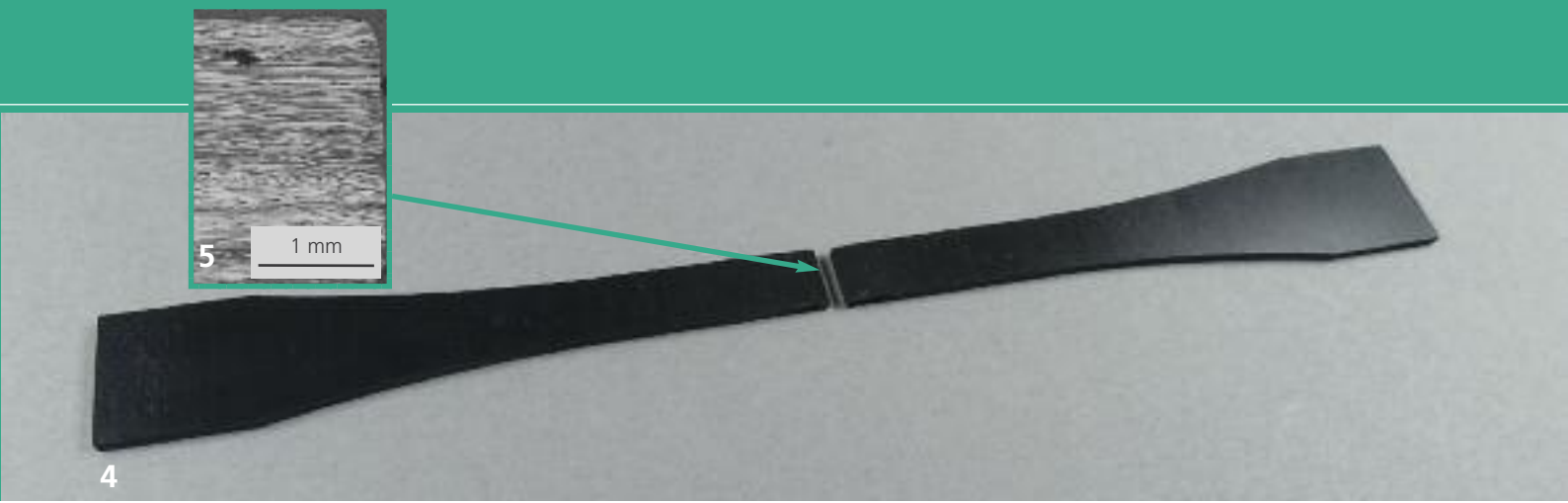

of all measurements fell. The reference data is obtained from parts that were completely fabricated by water jet cutting without any heat input. Thus the laser process results are already very close to the reference data.

High modulus carbon fibers have a high thermal conductivity along the direction of the fiber. The high thermal conductivity leads to a large zone that gets heat affected during laser processing. The goal is therefore to reduce the linear energy density during the process, which correlates directly with an increase of the processing speed.

By using galvanometer scanners, the spot velocity can be up to 10 m/s. This substantially reduces the interaction time of

laser and material and thus reduces the deposited linear energy density. During the experiments the processing parameters were optimized with the result that the thermal damage was negligible with minimal strength reduction of the material including high modulus carbon fibers.

- 1 CFRP test sample,
left: water jet cut,
right: test sample with sacrificial
laminate prior to laser cutting
- 2 Test sample mounted in the
tensile tester
- 4 laser processed and tested
sample
- 5 Cross section of the heat
affected zone

Change of the fracture tension as a function of the deposited linear energy density

material: HT and HM carbon fiber in epoxy matrix,
test sample thickness: 2 mm,
beam source: single mode fiber laser

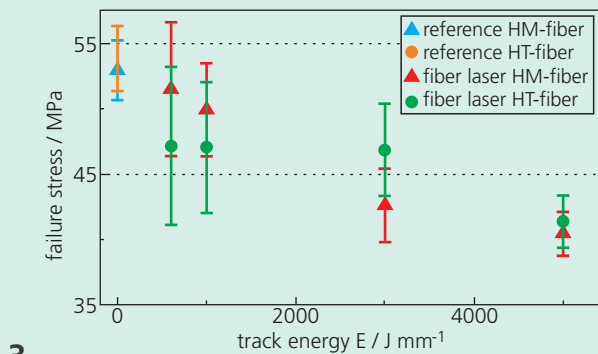

3

CONTACT

Dipl.-Ing. Andreas Fürst
phone +49 351 83391-3544
andreas.fuerst@iws.fraunhofer.de



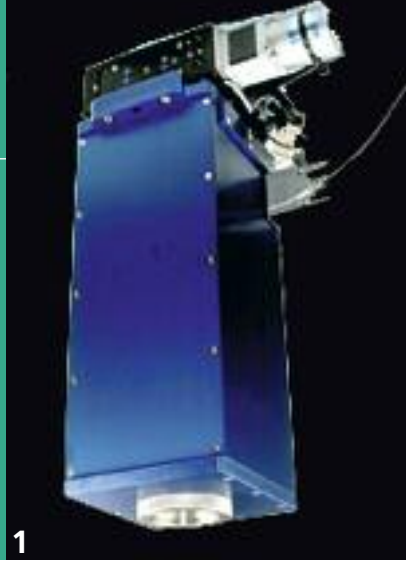

LASER STRUCTURING TO GENERATE INTERFERENCE COLOR EFFECTS

THE TASK

Periodic surface structures can generate color effects without the need for dyes. Such effects can be an attractive product protection but also a design element.

The direct fabrication of even monochromatic color effects on 2D and 3D surfaces is complex or sometimes even impossible. Lithographic techniques for example, require first the deposition of photoresist and then its exposure and development to open up surface areas of the substrate for subsequent structure etching.

The complexity of the lithographic approach is one of its challenges. Many processing steps are required and these increase the costs. The technique is also limited when treating 3D parts.

OUR SOLUTION

Direct laser interference structuring (DLIP) is one possible solution to apply periodic structure to the surface of 3D parts. The method produces highly accurate structures on various surfaces in a direct processing step without the need for chemicals. Visible effects result from the periodicity of the structure and the angle of observation.

Laser interference structuring uses a single laser beam. The beam splits and is then recombined on the surface of the part at a defined overlapping angle using optical elements (Fig. 2). The overlapping angle and the wavelength of the laser determine the resulting periodicity of the structures. Structure dimensions from 75 nm to 50 μm can be generated.

The goal of the Fraunhofer IWS scientists was to develop optical concepts for generating a diverse range of motifs with great efficiency and flexibility. The resulting solutions are automated processes for the efficient surface structuring of 2D and 3D parts (Fig. 1).

The optics can be tailored according to customer requirements to generate submicron and micron structures on different materials. It is possible to automatically generate multiple periods within one processing step.

RESULTS

Fraunhofer IWS engineers developed interference optics to generate freely selectable optical motifs. Structural periodicity as well as structure orientation can be varied. This capability

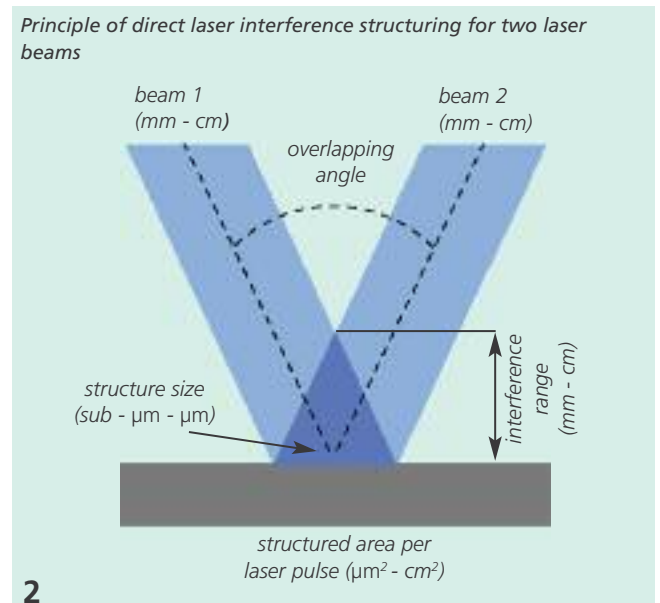

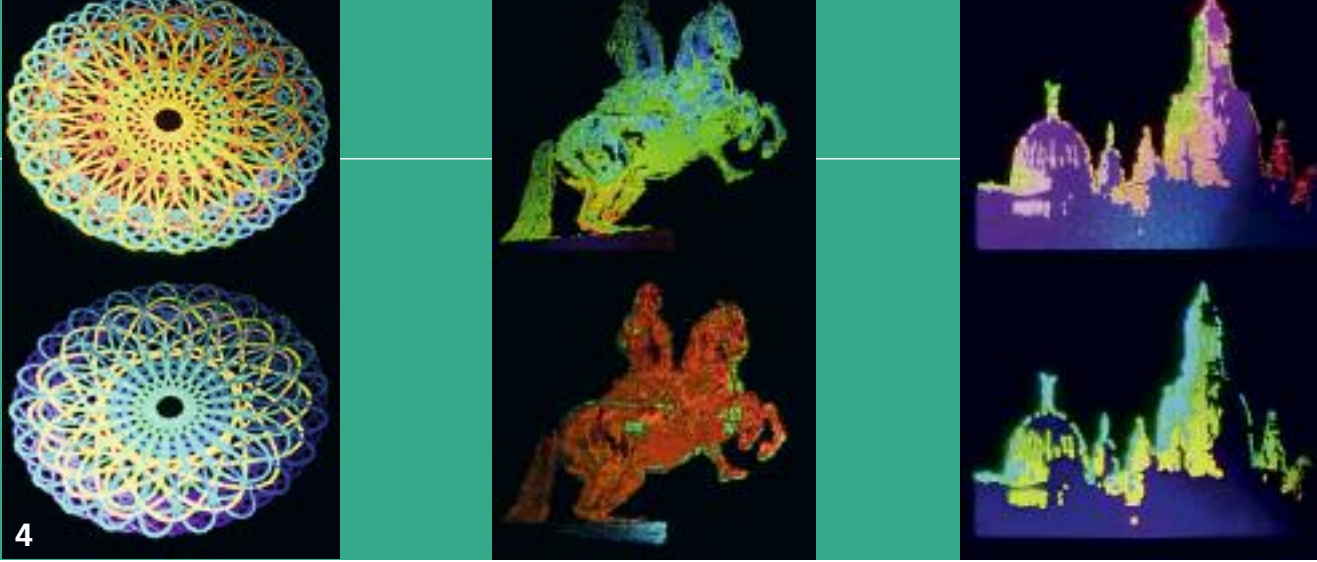

provides a broad range of possible surface structures that can be generated with a single optical system.

To transform motifs into interference images, standard software is used to first create raster graphics (Fig. 3). Each pixel represents a single laser structuring pulse. The different colors in the original motif are assigned to a specific structure period. The different structure periods create different colors at a given observation angle.

- 1 Processing head for direct laser interference structuring (DLIP)
- 4 Examples of DLIP structures nickel foils with varying motives

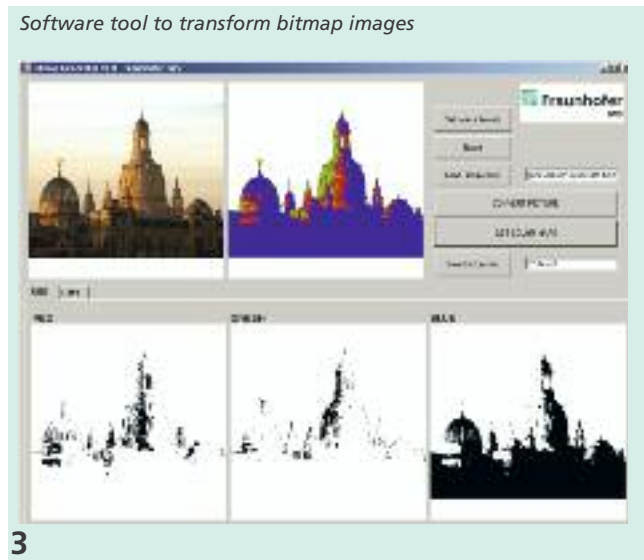

This is a relatively complex way to transfer a given motif onto a part, which makes reproduction by other means more difficult, thus providing better counterfeit protection.

The process can be used for metals, polymers, and ceramics and also for coatings from different materials. Examples of motifs generated with the process are shown in Fig. 4.

CONTACT

Dipl.-Ing. Sebastian Eckhardt
 phone +49 351 83391-3521
 sebastian.eckhardt@iws.fraunhofer.de





FABRICATION OF HOLLOW FIBERS FOR BIOREACTOR SYSTEMS BY 2-PHOTON POLYMERIZATION

THE TASK

The number of animals worldwide used for drug testing exceeds millions per year. Such tests are very controversial not only from the standpoint of animal protection. Animal models do not necessarily present accurate results if compared to humans. However, it is also undesirable to test potentially new drugs on humans. Therefore alternatives need to be developed to reduce the number of animal tests.

Multi-organ-chips (MOC) offer the possibility to test substances on different living cell cultures located in separate chambers. Such cell culture chambers are interconnected via small channels. However, analyzing complex cell cultures requires a supply system similar to human blood vessels.

Some initial studies were performed in a MOC-based perfusion micro bioreactor using biocompatible alginate hollow fibers. These hollow fibers were fabricated using a 3D scaffold printer. Human dermal microvascular endothelial (HDME) cells were used to simulate human blood vessels. This study, however, failed due to the insufficient biocompatibility of the fibers. The HDME cells died after having contact with the highly concentrated cross-linking medium calcium chloride. Thus, generating biocompatible hollow fibers and fiber networks, which simulate the human body, requires a new technology.

OUR SOLUTION

The Fraunhofer IWS approach is to embed the hollow fiber network in the perfusion micro bioreactor via a biocompatible polymer, which cross-links at room temperature due to 2-photon polymerization.

2-photon polymerization is an ultra short pulse laser process to generate real 3D microstructures. The process requires extremely high photon densities, which occur in femtosecond laser pulses. The highly intensive and focused near infrared laser radiation is nonlinearly absorbed and initiates the polymerization process of the liquid precursor through the 2-photon effect and suitable photo initiators. Unexposed material is subsequently removed by appropriate solvents.

The 2-photon polymerization process has several advantages:

- There are many suitable UV curable materials (e.g. SU-8, ORMOCER®) to fabricate desired structures.
- Resolutions can be achieved far below the diffraction limit, i.e. structures of 100 nm or less are principally possible.
- The laser beam is computer controlled based on 3D CAD models to fabricate complex three-dimensional micro- and nanostructures.

RESULTS

A collimated beam from a titanium sapphire laser was used to fabricate hollow fibers with an outer diameter of 150 μm , an inner diameter of 50 μm and a length of 1.4 mm (Fig. 1). The

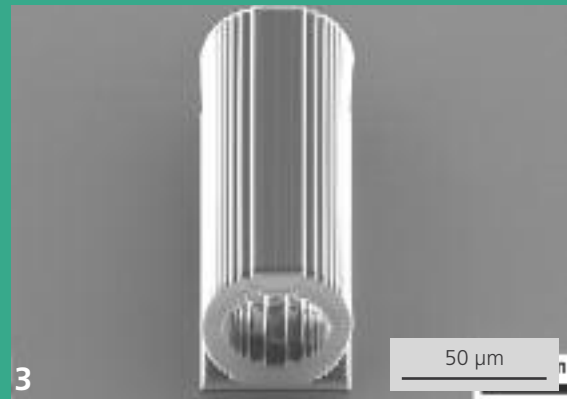
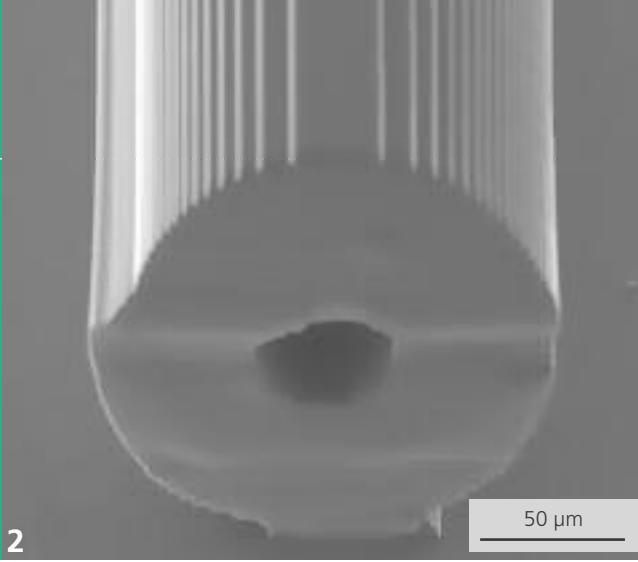

laser generates extremely short infrared light pulses which are focused through a 20 x objective into a liquid OrmoComp® solution. To fabricate the structure the laser focus is moved in x-, y- and z-directions through the photopolymer. The beam path is computer controlled following a three-dimensional CAD model at a speed of $100 \mu\text{m s}^{-1}$.

Structure parameters such as width and height strongly depend on pulse energy and writing speed with respect to the chemical reactions in the polymer (Fig. 4). Structural widths of 500 nm with a height of 3 μm in OrmoComp® are possible utilizing appropriate process parameters.

Structure height as a function of process speed and laser power during 2-photon polymerization of OrmoComp®

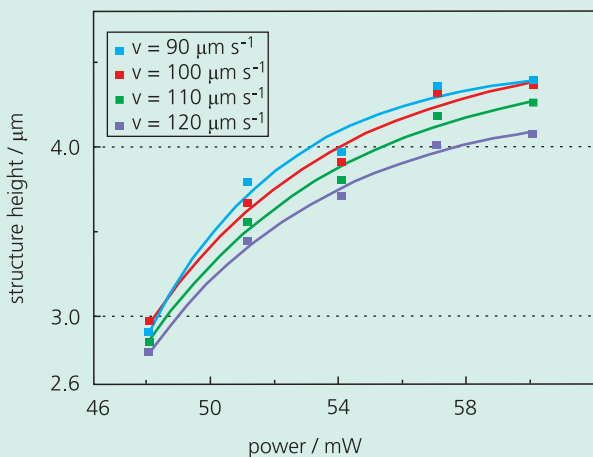

Initial flow tests were performed on hollow fibers fabricated by 2-photon polymerization. The result proved the existence of continuously hollow channels. The next step will be the biocompatible and leak-proof integration of the fiber in a bioreactor. Then the system will be characterized with respect to mechanical and fluidic properties such as permeability, perfusability and leakage. These data will be used for further optimizations of the fabrication process.

- 1 20 x focusing objective and fixture for the fabrication process of 3D microstructures
- 2 OrmoComp® hollow fiber fabricated with 2-photon polymerization process (length: 1.4 mm)
- 3 Hollow fiber with outer diameter of 70 μm and inner diameter of 50 μm

CONTACT

Dipl.-Ing. Matthias Bieda
 phone +49 351 83391-3348
 matthias.bieda@iws.fraunhofer.de



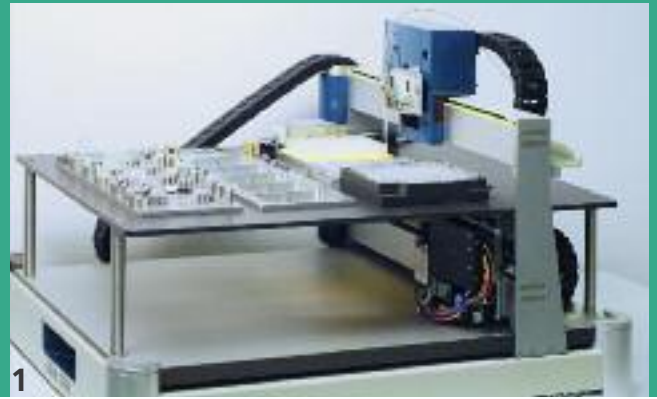

PINPOINT DOSAGE AND DETECTION IN LAB-ON-A-CHIP SYSTEMS

THE TASK

Lab-on-a-chip systems offer a high degree of integration, miniaturization and automation when implementing complex processes. The required technical and personnel resources are minimal. Such systems are very compact and easy to handle, which makes them also useable in the field. The potential of Lab-on-a-Chip systems is growing in many areas of biotechnology and medical engineering.

To reduce animal testing and to meet legal requirements (e.g. REACH regulation) more and more substance testing is performed using Lab-on-a-Chip systems. Similar to animal testing, the experiments study the reaction of cell and tissue cultures to varying dosages of substances and active ingredients for longer time intervals. This requires multiple Lab-on-a-Chip systems to be used simultaneously which have to be supplied and monitored over a longer period of time.

The two emerging technological challenges are the need for the continuous monitoring of vitality and functionality of cells and tissues as well as providing the supply streams to numerous systems in parallel for weeks. To solve this complex task requires this device to have two functionalities; the handling of liquid media (test substances, cell culture media) and noninvasive online monitoring (vitality determinations, oxygen measurement).

OUR SOLUTION

Fraunhofer IWS engineers developed a universal laboratory automation platform to automatically handle Lab-on-a-Chip

farms. The platform enables the continuous monitoring and providing supplies to such systems (Fig. 3). A two-level portal robotic solution was combined with a precise and sterile handling of fluids and various measurement systems for noninvasive online monitoring. User defined processes are performed completely automated.

Lab-on-a-Chip systems are placed on a temperature controlled holder plate, which is located between the two bridges. A freely positionable dosing head is mounted to the upper bridge. The head can be equipped with various fluid handling systems (active and passive pipettes) and tools (magnetic grippers, tweezers, RFID readers). A freely positionable sensor head is mounted to the lower bridge. The head can be equipped with various sensor systems (camera, microscope, fluorescence sensor). Each Lab-on-a-Chip system can be separately supplied with different media and subjected to noninvasive monitoring.

RESULTS

Together with industry partners Fraunhofer IWS engineers implemented this laboratory automation platform (Fig. 1). The dosing head received a passive pipette. The sensor head was fitted with a microscope and a fluorescence measurement system.



The holder plate offers space for ten Lab-on-a-Chip systems, several microtiter plates and a tip changing system, which consists of a magazine for one-way tips and measurement and ejection systems.

The prototype platform was tested with ten lab-on-chip systems over a period of 28 days. The lab-on-chip systems were automatically supplied with different media and monitored.

In a next phase the platform was successfully used for substance testing. Over 14 days human cells were tested in Lab-on-a-Chip systems and fully automatically supplied with media. Substances were dosed and samples were taken and analyzed by built in microscopy and fluorescence testing.

The results allow the conclusion that the developed laboratory automation platform is capable to supply media dosages and to detect responses with pinpoint accuracy.

- 1 *Prototype of the laboratory automation platform equipped with passive pipettes, microscope and fluorescence measurement system*
- 2 *Lab-on-a-Chip system in laboratory automation platform, media change completed, and fluorescence is being measured (blue light)*

Schematic design of the laboratory automation

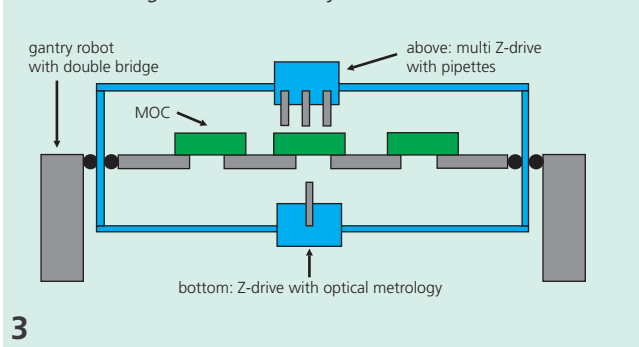

CONTACT

Dr. Frank Sonntag
 phone +49 351 83391-3259
 frank.sonntag@iws.fraunhofer.de



HEAD OF DEPARTMENT PROF. DR. BERNDT BRENNER



"The future belongs to those who realize its possibilities before they become obvious."

John Sulley



BUSINESS FIELD SURFACE TECHNOLOGY

Editor: An important pillar of the business field "Surface Technology" is the development of industrial-suited systems technology. What can you report about progress in this area?

Prof. Brenner: This business field's know-how in the area of deploying laser hardening technology to extend the service lives of turbine blades suffering from droplet impact wear was built up over many years. We have developed a new system to simultaneously harden the edges on both sides while integrating temperature control and flexible beam shaping. The machine works for complicated 3D parts through the use of two cooperating robots. Last year's highlight was the installation and production start of a machine at a world leading manufacturer of large power plants. Key activities focused on the transfer of the technology through the training of the customer's employees.

Editor: Does this mean your activities in this field have reached an end?

Prof. Brenner: No, quite the opposite. The successful implementation of this complex task generated an increase in customer inquiries, which implies important potential for further developments.

Editor: What do you mean in particular?

Prof. Brenner: I mean developments, not only quantitatively but also qualitatively. We are realizing that our desire to make a modular set of system components for industrial applications in laser surface processing makes sense. Coupling these components with customer specific motion systems is successful and opens various new avenues to implement novel applications.

Editor: Could you be more specific?

Prof. Brenner: Yes, certainly. The industrial use of laser beam hardening and surface refinement systems technologies is broadening. Applications such as the surface treatment of expensive, highly loaded and safety components require 100% quality control. A limiting factor was the absence of a mobile temperature reference. The customer needs this to discover temperature signal drifts, which can for example occur due to contamination of the laser optics and to recalibration of the machine. In an EU funded project, together with colleagues from PTB Berlin, we developed a mobile resettable temperature reference for short-term high temperature processes that can be mounted to customer systems. Alternatively, we can measure the customer machines by ourselves. We assume that this device will also be useful for other industrial high temperature processes such as friction welding, laser buildup and remelting and induction hardening.



COMPETENCES

TAILORED STEEL HARDENING BY LASERS AND INDUCTION

Certain component geometries, wear situations and materials may require protection beyond the capabilities of conventional hardening technologies. Laser beam hardening often offers novel solutions to generate wear resistant surfaces. This is particularly true for the selective hardening of components with multidimensionally curved, internal or hard-to-reach surfaces, bores or grooves as well as components sensitive to distortion. The workgroup offers:

- development of surface hardening technologies with lasers or induction or both
 - surface refinement of development and prototype samples
 - development of systems technology for laserhardening processes, process monitoring and control
-

COMPLEX MATERIALS AND COMPONENT CHARACTERIZATION

Mastering modern joining and surface technologies requires broad knowledge, from interpreting structural changes to understanding how they affect component properties. The workgroup offers access to modern equipment for structural analysis (metallography, SEM with EDX/WDX, HRTEM) and mechanical testing (among others, high frequency and multiaxial fatigue testing). Our customers rely on many years of experience in the field of structural and component reliability testing. The workgroup is a competent partner to perform property evaluation, failure analysis and application focused training.



HEAD OF DEPARTMENT

PROF. BERNDT BRENNER

phone +49 351 83391-3207

berndt.brenner@iws.fraunhofer.de



**GROUP LEADER
SURFACE TREATMENT**

DR. STEFFEN BONSS

phone +49 351 83391-3201

steffen.bonss@iws.fraunhofer.de



2013 PROJECT EXAMPLES

- | | |
|--|-----|
| 1. Laser doping of semiconductor materials with ultra short pulsed lasers | 108 |
| 2. Accurate temperature measurement for high temperature laser processes | 110 |
| 3. Laser hardening and buildup welding – two technologies in one processing head | 112 |
| 4. Fatigue endurance beyond the classic design limits | 114 |

**GROUP LEADER
MATERIALS CHARACTERIZATION**

PROF. MARTINA ZIMMERMANN

phone +49 351 83391-3573

martina.zimmermann@iws.fraunhofer.de



LASER DOPING OF SEMICONDUCTOR MATERIALS WITH ULTRA SHORT PULSED LASERS

THE TASK

The properties of semiconductor materials can be tailored by doping foreign atoms into their lattice structures. These materials find applications in numerous areas. Silicon, for example, is used in photovoltaics, sensors, electronics and many other applications.

The tailored doping with foreign atoms defines the type of charge carriers and whether the material becomes an electron or hole conductor. Currently two industrial scale technologies are used to produce defined doping profiles. Thermal doping using diffusion processes and ion implantation is based on applying electric fields. Both processes require substantial heat in the substrates. To substitutionally place foreign atoms inside the crystal lattice, it is required to heat the semiconductor substrates for several minutes to above 200 °C.

Certain applications however, such as the fabrication of heterojunction solar cells, require that all processing steps keep the substrate below such temperatures. Therefore the established processes cannot be used. New solutions have to be qualified for industrial use.

OUR SOLUTION

Laser doping heats and melts the substrate locally to insert foreign atoms. The use of highly dynamic scanner technologies makes it possible to implement individual layouts such as defined current paths or complex doped surfaces on the semiconductor materials.

The dopants are delivered to the processing location via spin-coating or dispense printing. Dopants are provided either in liquid form or as a hydrogel.

RESULTS

Fraunhofer IWS engineers tested various laser types and wavelengths depending on the desired doping profile and the thermal load limits of the substrates.

A uniform melting of the material and a deeply penetrating doping profile is achieved with continuous wave laser systems. Pulsed systems such as ultra short pulsed lasers deposit energy very briefly. The melting therefore occurs only near to the surface.

The degree of depth penetration depends on the laser wavelength and its absorption in the material. Silicon, for example, has optical penetration depths of 100 µm at a wavelength of 1064 nm and 1 µm at a wavelength of 532 nm.

When the melt cools down, and depending on the process parameters, the dopants are built into the semiconductor lattice. The solidification of the liquid material occurs epitaxially, which preserves the lattice structure of the base material.

By varying the doping parameters for silicon at a laser wavelength of 1064 nm it is possible to achieve a nearly uniform depth penetration of phosphorus into the material at different degrees of activation (Fig. 1).

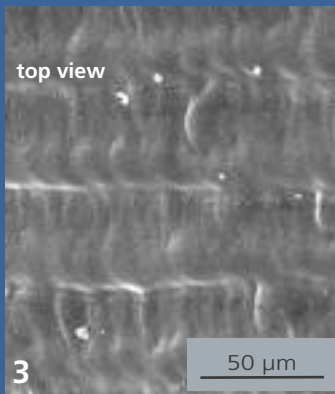
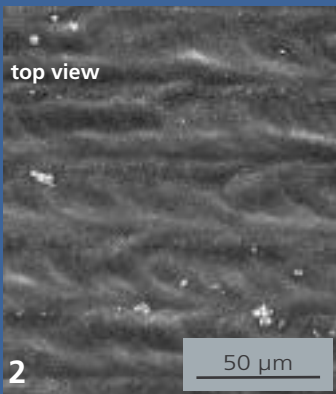
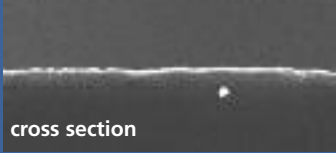

The remelting of the semiconducting material can also tailor the surface of the doped areas. Textured surfaces such as those covered with pyramidal structures can be leveled in certain areas to obtain better properties for electric contacts. It is also possible to create a wavy surface topography (see Fig. 2 and 3).

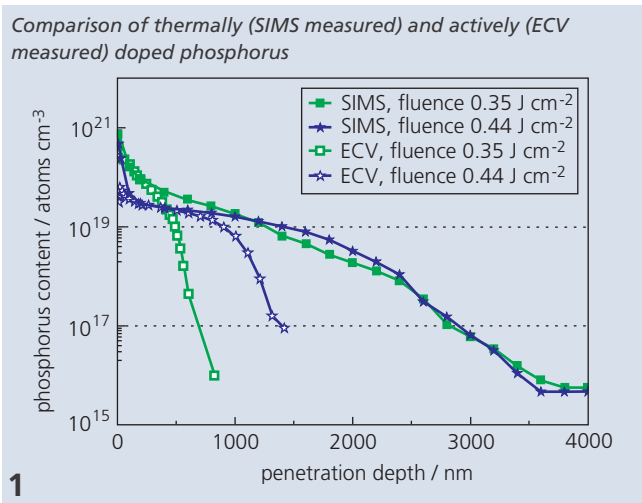

- 2/3 Surface topography
top view and cross section
- 2 Fluence = 0.35 J cm⁻²
- 3 Fluence = 0.44 J cm⁻²

The locally high temperatures in combination with process gases such as oxygen and nitrogen can lead to the formation of electrical passivation layers. The laser process is synergetic as it can combine several processes in semiconductor fabrication.

These works were performed in collaboration with project partners Namblab GmbH, Roth and Rau GmbH, ULT AG, ILK Dresden, Rehm and the Fraunhofer IKTS.

CONTACT

Dipl.-Ing. Niels Schilling
 phone +49 351 83391-3436
 niels.schilling@iws.fraunhofer.de



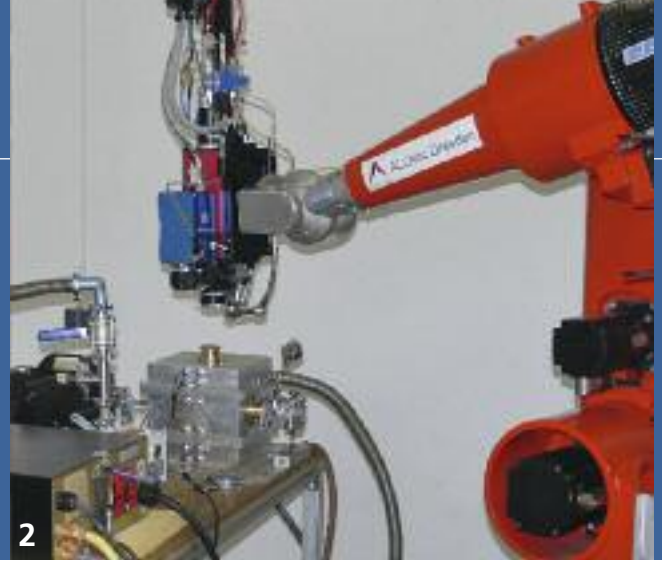

ACCURATE TEMPERATURE MEASUREMENT FOR HIGH TEMPERATURE LASER PROCESSES

THE TASK

The quality control demands during industrial laser processes such as laser hardening are high. Contact free temperature measurements with pyrometers and thermal imaging cameras become increasingly important. Often absolute temperatures have to be determined within 5 K accuracy to keep high temperature laser processes stable and to ensure that the process results are within the acceptable tolerance window. In addition to device specific uncertainties, the characteristic curves of the devices may change due to contamination of components, and the emission coefficients of real part surfaces may not be properly corrected. Such effects are the main error sources in industrial temperature measurements above 1000 °C.

Users of pyrometers and thermal imaging cameras require certified calibrations for their devices if they are used for quality control. Such devices need to be much more accurate than what has been common thus far. They also need to measure mobile and safe to handle. Measurement cycle times should be as short as possible to minimize stoppage durations of series production machines. Another limitation is the available database for application related emissivity corrections of the devices. As this data does not meet the increasing requirements for accuracy, systematic measurements with current technology is necessary.

OUR SOLUTION

In collaboration with the national metrology (PTB) institute in Berlin, Fraunhofer engineers developed a calibration device based on inductively heated high temperature fixed points (Fig. 1).

The calibration principle is based on stabilized fixed point temperatures at the simultaneous presence of liquid and solid phases of ultrapure metals or eutectic metal alloys. The device is optimized for the temperature range from 1000 °C to 1500 °C.

Fraunhofer IWS engineers successfully tested the prototype for applications. Copper fixed points (calibration temperature $T_{\text{cal}} = 1085 \text{ °C}$), iron-carbon fixed points ($T_{\text{cal}} = 1153 \text{ °C}$) and cobalt-carbon fixed points ($T_{\text{cal}} = 1323 \text{ °C}$) were used. The reproducibility of these fixed points is about 1 Kelvin. The calibration device can reliably detect the smallest measurement inaccuracies so that they can be corrected.

The emissivity of steels and cast iron were systematically measured on selected samples. Experimental setups were used at the ZAE Bavaria and the PTB Berlin. Influencing factors are the alloy content, the surface roughness, the degree of oxidation, the wavelength of the measurement and the temperature dependence itself. The sample states were selected so as to cover the widest possible application range.

RESULTS

The fixed point calibration device was tested in two industrial laser beam hardening applications. Temperature deviations of up to 10 K were detected. Such deviations are mainly caused by contaminated optical components within the beam path of the temperature measurement. The continuously advancing contamination of protective windows by process vapors in particular has to be taken seriously.

Measurement errors due to the attenuation of the

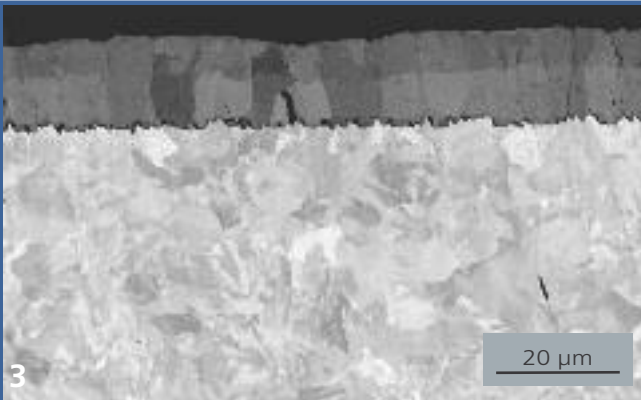

temperature signal as well as absorption and scattering of the laser radiation are often underestimated.

A calibration device based on the newly developed concept has the advantage that it can be applied directly onsite to verify the measurement system used in the application. Some laser processes suffer especially high wear of optical components. Here it may be suitable to deploy the calibration device in-situ between individual processes to ensure the proper function of the system prior to each process.

The spectral emissivity as a function of several factors was measured for hardenable steels and cast iron. The data is provided to users to enable them to correct emissivities. Polished samples showed some dependence of the emissivity from alloying elements, which reduced with increasing roughness. With increasing roughness the emissivity increases substantially. For high measurement wavelengths in the micrometer range especially, this increase may be as high as 100%. This has substantial consequences for temperature measurements.

If the surfaces are oxidized at high temperatures the oxide films generate interference effects. These lead to drastic fluctuations of the emissivity, which falsifies the temperature

measurements. Measurement wavelengths below 1 μm showed a saturation of the emissivity at about 0.8 already for very thin oxide films (Fig. 4).

A precise temperature measurement on steel and cast iron surfaces at temperatures above 1000 $^{\circ}\text{C}$ is principally possible. In addition to precise calibration, it is necessary to select an optimal measurement wavelength depending on the application and also to use the associated emissivity correction data.

These works were performed as part of the EMRP project "HiTeMS" (EMRP A169, JRP IND01). The European Union and the EUAMET partner countries fund the European metrology research program EMRP jointly.

- 1 Fixed point cell inside induction coil
- 2 Prototype of an inductively heated fixed point calibration device to verify the temperature measurement system in an industrial laser hardening machine
- 3 SEM image of a laser hardened sample from carbon steel C45 with oxide layer on the surface

Spectral emissivity of steel 42CrMo4 as a function of oxide film thickness

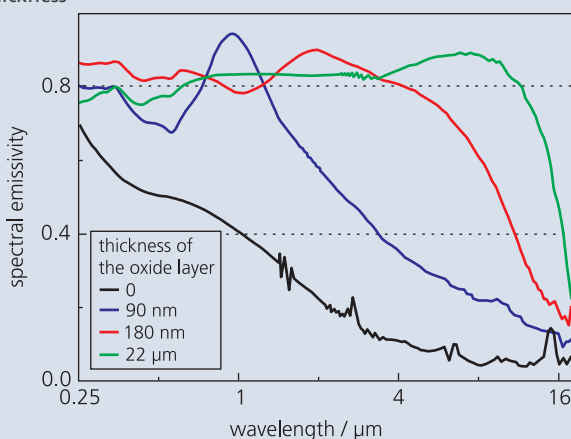

CONTACT

Dipl.-Phys. Marko Seifert
phone +49 351 83391-3204
marko.seifert@iws.fraunhofer.de





LASER HARDENING AND CLADDING – TWO TECHNOLOGIES – ONE PROCESSING HEAD

THE TASK

Laser cladding and laser hardening are well established processes which have been developed for many industrial applications over the last 20 years. These processes are carried out on many industrial applications, although typically these have been limited to external surfaces and easy to access features on components. One example is where laser cladding and hardening processes are used to improve the wear and corrosion performance on bearing surfaces and outer contours of oil drilling equipment components.

Since this technology proved to be very successful for external tube surfaces, it should be transferred to hard to reach internal surfaces of cylinders and tubes. Therefore, Fraunhofer CCL's Laser Division, a branch of the Fraunhofer IWS, situated in Plymouth, Michigan, USA moved forward with the development of a new processing head and the corresponding process technology for internal cladding processes of tubes for the North American oil industry. Since the original development a large number of these ID cladding systems have been introduced into numerous production lines under the name ID1 and ID2 (ID= internal diameter).

Following on from this, many industrial customers have expressed the desire to be able to carry out laser hardening in similarly confined spaces. This interest required a further development and adaption of the existing solution, particularly the processing optics.

OUR SOLUTION

The laser focus spot size for the ID laser cladding process is approximately 6 mm diameter, and whilst ideal for laser cladding, this is not particularly suitable for laser hardening. Therefore we developed a completely new end effector for the processing arm, which features integrated optics in order to produce a homogenous energy density across a larger spot size.

Presently the focus spot is 20 x 8 mm². If different optics are applied other square and rectangular spot sizes of up to 25 x 25 mm² are also possible.

The overall arm construction is similar to our ID cladding head design featuring integrated water cooling and beam delivery. The head can operate at up to 3 kW maximum laser power, and the initial prototype head has been tested using both Disk and Fiber lasers.

Systems technology specifications for ID cladding and hardening.

technology	laser hardening inside	cladding inside
processing head	ID-H	ID2
minimum tube diameter	76 mm (~ 3")	89 mm (~ 3,5")
maximum depth	1000 mm (39.4")	
maximum laser power	3 kW	
compatible laser	Fiber, Disk, Nd:YAG	

3



RESULTS

The ID head enables the hardening of components with confined spaces, made of hardenable steel and cast iron. The head is extremely suitable for internal areas of rotating tubes and cylinders.

Initial results from trials using our ID-H head look promising. A hardness increase of approximately 16 mm with an effective case depth of approximately 1 mm could be achieved across a track width of a 42CrMo4 (4140) steel component. The processing head can be applied for internal diameters of up to 76 mm and a depth of 1000 mm.

The processing heads ID1 and ID2 enable cladding processes to be performed up to 1000 mm deep inside bores with as small as 89 mm internal diameter. The head features internal water cooling, shield gas, metal powder and laser beam delivery channels. Thus it is extremely compact and reliable, even at difficult-to-access positions.

Since the first development several processing heads have been successfully implemented into industrial applications, especially for North American oil companies.

- 1 ID laser cladding process on cylinder bore
- 2 ID Laser hardening process on cylinder bore

Cross section of a hardened 42CrMo4 component (focus spot 20 x 8 mm²) and hardness-depth curve

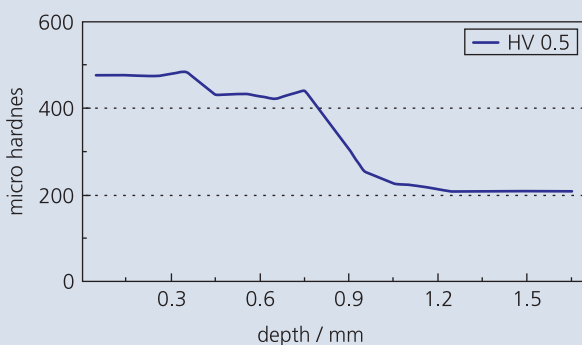
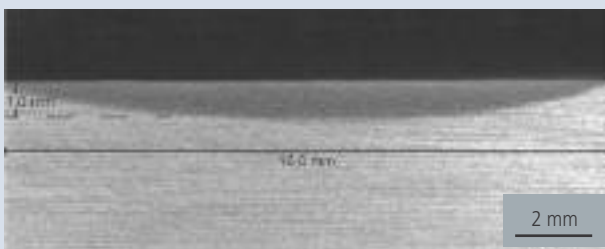

CONTACT

Craig Bratt
 phone +1 734 738-0550
 cbratt@fraunhofer.org





FATIGUE TESTING BEYOND THE CLASSICAL ENDURANCE LIMIT

THE TASK

The cyclic strength and the deformation properties of structural components are the dominating objectives to be achieved by latest material and manufacturing strategies in many application fields. Safety relevant components, e.g. in aerospace and automotive industries, in railway vehicles and in turbines and power plant constructions, have to endure cyclic mechanical loadings far beyond the classical fatigue limit. Due to high frequency loading (e.g. 2000 Hz) or very long durations (e.g. more than 30 years) the number of loading cycles easily exceeds 10^9 . In order to develop fatigue life prediction concepts with utmost reliability, extensive experimental investigations have to serve as a basis for an understanding and prediction of the damage and failure mechanisms in this range of loading cycles.

Latest research activities in the so-called field of "Very High Cycle Fatigue" (VHCF) could prove that many materials (high strength steels, aluminum and nickel base alloys etc.) show crack initiation resulting in failure even beyond the classical fatigue limit. The reason for failure in the VHCF range is mostly related to microstructural inhomogeneities and defects such as nonmetallic inclusions, coarse precipitations, phase boundaries, unfavorably oriented grains or manufacturing related flaws and micro notches. Current VHCF investigations are still focussing on the fundamental understanding of the correlation between damage mechanisms and material microstructure. Hence, a prediction of the VHCF behavior of structural components on the basis of statistically reliable concepts is still a true challenge since the complexity of damage processes increases with an increasing influence of design strategies and manufacturing processes.

OUR SOLUTION

The Fraunhofer IWS responded to the globally increasing demand for research and development activities in the field of VHCF by installing a new laboratory with most up-to-date high frequency fatigue testing technology in 2013. The test systems available are a resonance pulsation test stand and an ultrasonic fatigue test stand (Fig. 1), allowing test frequencies of 100 - 150 Hz at maximum forces of ± 50 kN and about 20000 Hz, respectively. Thus, a number of loading cycles up to 10^{10} can be realized at reasonable test periods.

The well-equipped resonance pulsation test system covers a wide range of tests. Cyclic tension-compression tests can be applied with or without superimposed mean loads and 3- or 4-point bending tests are possible. Moreover, the system allows fatigue crack propagation studies as well as for isothermal experiments up to 900 °C. Tests are not only limited to flat or round material samples, but component-like symmetrical samples can be investigated as well. In combination with the ultrasonic fatigue testing system, investigations concerning direct and indirect frequency influences on the fatigue behavior can be performed.

Recently, ultrasonic fatigue testing has become a well-established experimental method in the field of VHCF research. The system uses piezo ceramic actuators to excite a sample to its natural resonance (Fig. 2). The excitation results in a propagation of a sinusoidal mechanical wave along the longitudinal axis of the sample. The load amplitude is calibrated by means of strain gauges mounted on the sample's surface in the critically stressed region. A closed-loop control of the excitation guarantees constant load amplitudes even in case of a micro-crack formation. The failure criterion of the

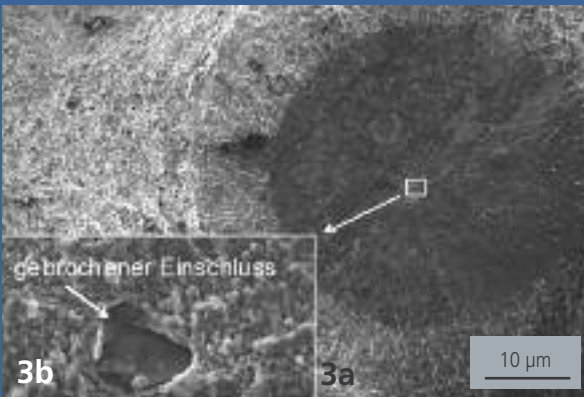

sample can be directly correlated to the change of the resonance frequency allowing for a very sensitive and reproducible shutoff signal.

In order to avoid undesirable heating at high frequencies, samples are actively cooled by means of compressed air during testing. Moreover, the test regimes are also adjusted in terms of pulse-pause sequences based on the material specific damping properties.

The ultrasonic fatigue test system is equipped with an additional load frame in order to superimpose static mean loads. Moreover, fatigue tests with variable load blocs can be performed by means of an external control unit. The computer control unit allows a definition of loading scenarios close to realistic applications while feedback signals are registered and load sequences are classified. Early damage detection becomes available by means of registering the resonance frequency and the higher harmonics of the feedback signal throughout the tests, even in case of crack initiation in the interior volume of the sample as is often observed in the VHCF regime (Fig. 3).

S-N-curve showing the fatigue strength up to crack initiation measured by means of an ultrasonic fatigue test system at a stress ratio of $R = 1$

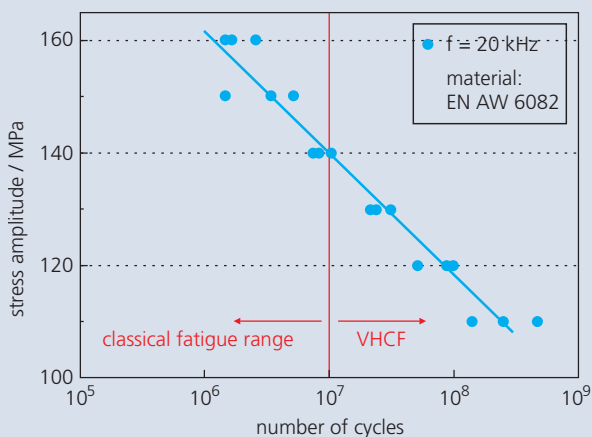

4

RESULTS

In order to identify the influence of single parameters of laser welding processes on the fatigue behavior, a test series started, analyzing the cyclic strength of the as-received condition of the base material used for the welded joint. As expected, the aluminum alloy EN-AW 6082 showed a significant decrease of its cyclic strength even beyond the classical endurance limit of 107 numbers of loading cycles (Fig. 4).

However, compared to results from scientific investigations of other researchers, the VHCF strength of the samples tested turns out to be slightly higher than that of the experimental data already available. This underlines the effect of batch variation and thus the importance of pre- and post-processing. Reference experiments at conventional frequencies indicate an influence of this particular test parameter. Future investigations also have to prove whether such factors as the sample calibration process, the shutoff signal or the environmental conditions will have an effect on the VHCF behavior. Our next step in establishing VHCF research at IWS will be to develop sample geometries and test routines to analyze the different zones of a welded joint separately.

- 1 Starting a test series at the ultrasonic fatigue test stand
- 2 Single-side clamping of the ultrasonic fatigue test specimen
- 3a Crack initiation at a non-metallic inclusion
- 3b Detail view of the crack initiation region

CONTACT

Prof. Martina Zimmermann
phone +49 351 83391-3573
martina.zimmermann@iws.fraunhofer.de



CENTERS

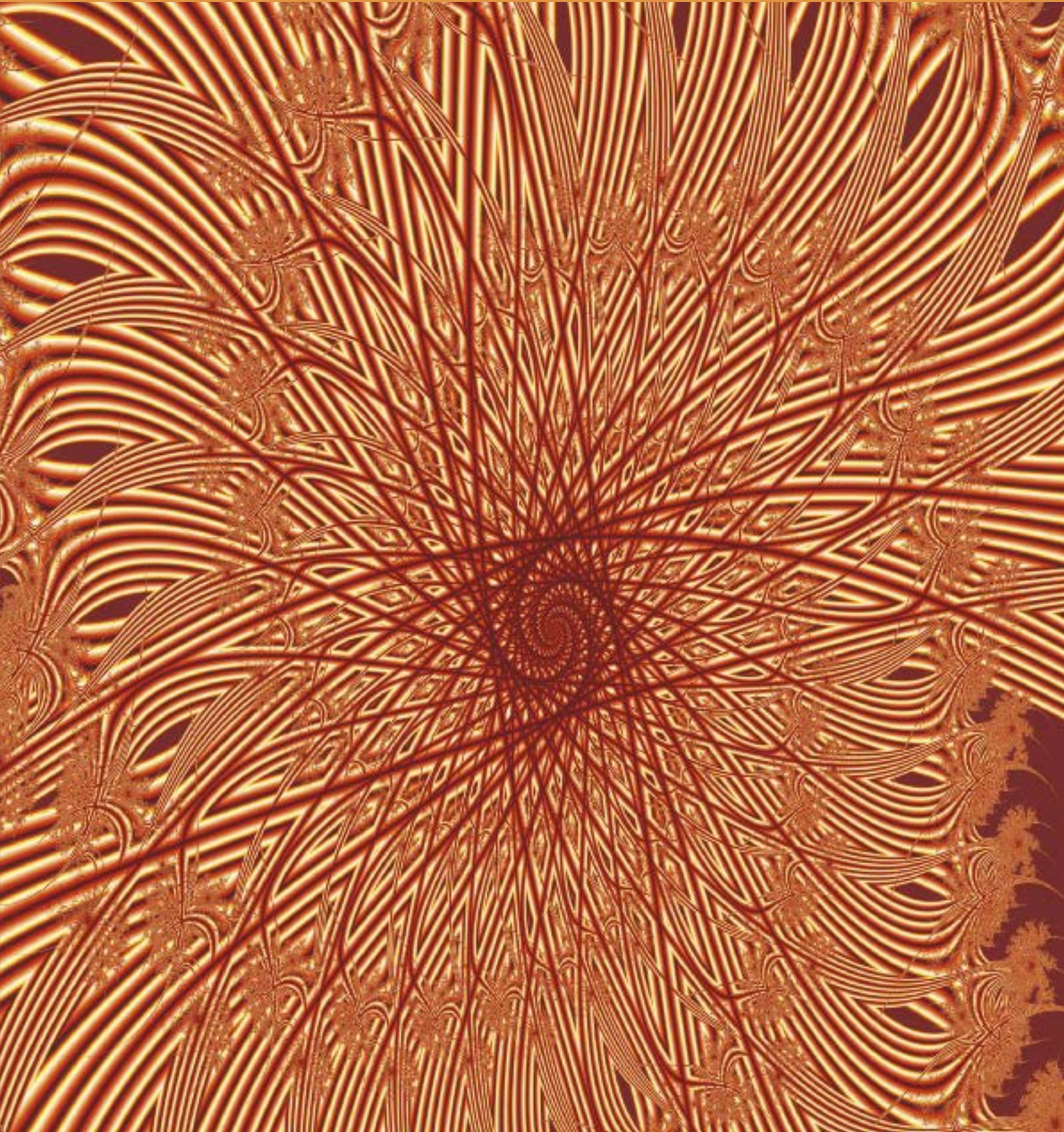



BATTERY RESEARCH CENTER – FOR NEW ENERGY STORAGE SYSTEMS

Research in the areas of electromobility as well as stationary energy systems is a central theme at IWS in Dresden. Important contributions can be provided to battery fabrication processes based on the numerous IWS manufacturing process technology development areas. To be in the position to offer solution to industry, the IWS is establishing a center for battery research. The EU and the Free State of Saxony fund this project with 4 million Euros. IWS internal and Fraunhofer funds add 3 million Euros. BMBF project funds contributed another 1 million Euros for equipment. This offers the best conditions to work on numerous public industry projects of which are listing here a selection:

AlKaSuSi (BMBF: FZJ 03X4618A)

Material concepts for alkaline metal sulfur batteries

Timeframe: 05/2011 – 04/2014

DryLIZ (BMBF: KIT 02PJ2302)

Dry fabrication of lithium ion cells

Timeframe: 01/2012 – 12/2014

MaLiSu (EraNET/BMWi: DLR 01MX12009A)

Nanomaterials for future generation Li-S-batteries

Timeframe: 01/2012 – 12/2014

CryPhysConcept (BMW/BMU/BMBF: FZJ 03EK3029B)

With crystal physics to future concepts of electrochemical energy storage systems

Timeframe: 10/2012 – 12/2015

BaSta (BMU: FZJ 0325563A)

Battery – Stationary in Saxony

Timeframe: 11/2011 – 10/2015

COORDINATION

MATERIALS DEVELOPMENT

DR. HOLGER ALTHUES

phone +49 351 83391-3476

holger.althues@iws.fraunhofer.de



MANUFACTURING TECHNOLOGY

DR. PHILIPP THÜMMLER

phone +49 351 83391-3215

philipp.thuemmler@iws.fraunhofer.de



www.iws.fraunhofer.de/battery

BatCon (BMW: DLR 01MX12055C)

Functionally integrated high current connectors for battery modules,

Timeframe: 1/2013 – 12/2015

PLIANT (EU: FP7-NMP-2012-LARGE-6)

Process Line Implementation for Applied Surface Nanotechnologies,

Timeframe: 01/2013 - 01/2017

BamoSa (BMBF: FZJ 03X4637A-H)

Battery – Mobile in Saxony

Timeframe: 06/2013 – 05/2016

In 2013 the Fraunhofer IWS organized the workshop “Lithium-Sulfur-Batteries” for the second time. The workshop was highly recognized and welcomed even more attendees than in the previous year. Prestigious experts from industry and science presented and discussed the latest development trends in the field of Li-S batteries. The next workshop will be held on November 12th and 13th 2014.



TAILORED JOINING CENTER – CONCENTRATED COMPETENCE IN DRESDEN

Joining is a central production challenge and also a significant cost factor. In many cases current joining technology developments offer significant improvements and impulses. Therefore the Fraunhofer IWS in cooperation with the TU Dresden and other partners established the joining technology center “Tailored Joining”. The center is designed to provide an overview to users of joining technology, to show the different processes, their advantages and limitations. New developments will be presented and industrial solutions will be shown.

The basis of the center is formed by the enormous bandwidth of available joining technologies in Germany and also internationally. IWS performs research on all of these methods:

- laser beam welding
- laser hybrid processes (plasma, arc, induction)
- laser brazing (hybrid) and reactive multilayers
- magnetic pulse welding (forming + welding)
- friction stir welding
- diffusion welding (laser induction roll plating)
- adhesive bonding

The following joining processes are subject to research of our partners at the TU Dresden:

- classical arc welding processes
- brazing processes
- friction stir welding
- mechanical joining

We are looking forward to welcoming the Hochschule für Technik und Wirtschaft (HTW) Dresden to our center in 2014. They will contribute their expertise in the field of electron beam technology.

COORDINATION

DR. GUNTHER GÖBEL

Phone +49 351 83391-3211
gunther.goebel@iws.fraunhofer.de



PUBLIC RELATIONS

CLAUDIA ZELLBECK

Phone +49 351 83391-3332
claudia.zellbeck@iws.fraunhofer.de



www.iws.fraunhofer.de/joining

Special effort is spent on presenting a fair comparison of the various solutions. The goal is to provide the user with insightful help when selecting which technology would best meet the application’s needs.

Encouraged by the prior remarkable success, we are organizing the second symposium “Tailored Joining”, which will be held in the International Congress Center Dresden on February, 27th and 28th, 2014. The huge variety of latest joining procedures and their current developments will be presented and discussed. A new part of the symposium will offer practical demonstrations in our partners’ laboratories. Thus newcomers will get the opportunity to quickly become familiar with this new technology and to evaluate its limits and possibilities.



LASER INTEGRATION CENTER – MANUFACTURING TECHNOLOGY

For many years the Fraunhofer IWS has aimed at increasing the competitiveness of Germany's machine and plant building industry by providing laser technology. Dresden's researchers have already delivered numerous innovative technologies and systems to industrial customers. A special brochure compiled a selection of such successes, which was issued for the 20th anniversary of the institute.

The institute's activities continue to be driven by branch over-arching applied research for industry. IWS networks and collaborations with other research institutions and industrial partners are concentrated within the center for laser integration in manufacturing. The goal is to offer customer "one step" solutions.

The advantages for machine and plant builders as well as manufacturers are evident:

- cost savings due to reduced process chains,
- higher efficiency of the manufacturing processes and products,
- higher quality and market relevance of the products,
- competitive advantages at the highest technical level.

The implementation of the laser hardening system for the simultaneous hardening of steam turbine blades with two lasers and a laser hardening system with one laser were our latest technology transfers. Furthermore the laser hardening system for brake handles in truck trailers' axles was put to industrial application. Further implementations of the year 2013 can be found on page 6 and 7.

Public relations and knowledge dissemination are important components of technology transfer. This is the reason for many Fraunhofer IWS exhibitions at numerous annual trade

COORDINATION

DR. STEFFEN BONSS

Phone +49 351 83391-3201
steffen.bonss@iws.fraunhofer.de



PUBLIC RELATIONS

CLAUDIA ZELLBECK

Phone +49 351 83391-3332
claudia.zellbeck@iws.fraunhofer.de



www.iws.fraunhofer.de/en/laserintegration

shows. In 2013 the institute exhibited at the Hannover trade-show, the "EMO", the "Schweißen und Schneiden", the "Härtereikongress" and the "Euromold". We particularly focus on continuously enhancing our relations to our neighboring countries.

The 8th International Laser Symposium will combine the previous events "Industrial applications of high power diode lasers", the joining technology symposium "Tailored Joining" and the "International laser symposium Fiber & Disc (FiSC)" into one unique conference. This event will be held at the International Congress Center in Dresden on February 27th and 28th 2014. A comprehensive program, an exhibition and an IWS Open House invitation particularly addresses our visitors from industry.

www.lasersymposium.de



NANOTECHNOLOGY CENTER – NANO IN FOCUS

Nanotechnology offers innovation and delivers important contributions to energy and resource efficiency. It is a cross sectional technology overarching many branches. A close cooperation between research organizations and companies is required to faster and better utilize nanotechnologies in applications. The Fraunhofer IWS has been actively participating in this effort since years. Activities include internal research works as well as the coordination of and participation in numerous initiatives.

Research works at the IWS in this field addresses in particular:

- from micro to nano: high power laser for surface structuring processes (pages 36/37)
- multilayer Laue lenses for high resolution X-ray optics (pages 50/51)

These works are of increasing interest for industrial applications.

Presently the Fraunhofer IWS, together with state capital Dresden is organizing the 10th International Nanotechnology Symposium "Nanofair – new ideas for industry" to be held in Dresden on July 1st and 3rd 2014. The program will include more than 40 presentations and contributions from renowned international experts. Topics include nanomaterials for lightweight construction, electronics, optics, energy applications, nanoanalytics and special process aspects. A new highlight of the conference will be the integration of the "Dresden Nanoanalysis Symposium", which will address topics in the field of nanoanalytics.

The Fraunhofer IWS is actively engaged in transferring research results to manufacturing. For years the institute has participated in the "nano tech" fair in Tokyo, Japan. Furthermore, fair trade presentations at the Fraunhofer joint booth at

COORDINATION

PROF. ANDREAS LESON

Phone +49 351 83391-3317
andreas.leson@iws.fraunhofer.de



PUBLIC RELATIONS

DR. RALF JÄCKEL

Phone +49 351 83391-3444
ralf.jaekkel@iws.fraunhofer.de



www.iws.fraunhofer.de/nanotechnology

the tradeshow "Hannovermesse Industrie " and the "EMO" further addressed this topic.

On December 12th 2013 the initiative "Nano in Germany" elected Prof. Andreas Leson as their spokesman for further two years. Prof. Leson is the deputy director of IWS Dresden and also head of a department at the institute. The initiative "nano in Germany" aims at making the topic nanotechnology even more visible and focusses on its huge market potential.

The IWS Dresden coordinates the nanotechnology competence center "Ultrathin Functional Coatings" (Nano-CC-UFS). The center's membership includes 51 companies, 10 university institutes, 22 research organizations and 5 associations. Members collaborate in the areas of public relations and technology transfer. The IWS is also a member of the Fraunhofer Alliance Nanotechnology and in Dresden's cluster for nanoanalytics and the network "Organic Electronics Saxony".



CARBON TECHNOLOGY CENTER – UNIQUE VARIETY AT FRAUNHOFER IWS

Carbon is a special element with extraordinary versatility. Its various modifications and compounds have a broad property and applications spectrum. For years carbon has played a central role in Fraunhofer IWS research. Here are some examples:

Diamond-like carbon (ta-C) to reduce friction and wear are an important research focus in the business field PVD and Nanotechnology. For many years the research has addressed the link between coating properties and deposition process. Now Fraunhofer IWS developed systems technology to deposit ta-C has found its way to industry. Two industrial applications could be implemented in 2013 (pages 44/45).

Graphite-like carbon (GLC) has predominantly graphitic bonds and thus an associated high electrical conductivity. IWS engineers use a modified deposition technology to synthesize these coatings. They are characterized by a low contact and a high chemical corrosion resistance. A special laser structuring process is also used to locally graphitize diamond-like coatings.

Carbon nanotubes (CNTs) are characterized by their high electrical conductivity. Vertically aligned carbon nanotubes serve as conductive and binder free matrix for contacting sulfur in lithium sulfur batteries. IWS engineers produce single wall carbon nanotubes in a gas phase, which are increasingly used in sensor and actuator applications. Thin CNT-coatings enable the fabrication of transparent, conductive layers with high flexibility and actuator characteristics. By integrating CNTs into polymer surfaces IWS scientists could improve their anti-static features.

COORDINATION

PROF. STEFAN KASKEL

Phone +49 351 83391-3331

stefan.kaskel@iws.fraunhofer.de



PUBLIC RELATIONS

DR. RALF JÄCKEL

Phone +49 351 83391-3444

ralf.jaekel@iws.fraunhofer.de



www.iws.fraunhofer.de/carbon

Carbon fibers are another highly topical subject. IWS scientists' research focus includes coating processes of carbon fibers with respect to their integration into polymer matrices as well as cutting and joining process steps for carbon-reinforced polymers.

Mono and polycrystalline diamond is of great interest for optical, X-ray optical and electronic applications. At its Lansing, MI, USA subsidiary Fraunhofer CCL, IWS produces diamond from the vapor phase by homoepitaxial chemical vapor deposition (pages 38/39).

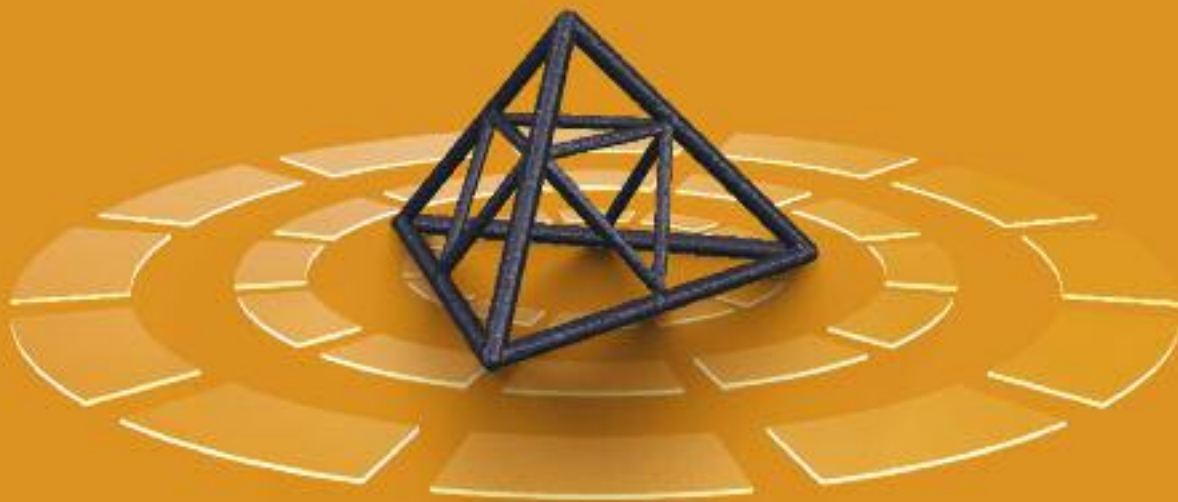

COMPOSITE TECHNOLOGY – TECHNOLOGIES FOR MODERN LEIGHTWEIGHT CONSTRUCTION

Lightweight structures, consisting of fiber composite materials and tailor-designed part geometries can excellently meet the demanding requirements to cost and energy-saving products. To reduce the costs for these structures, the scientists of the Fraunhofer IWS Dresden and experts from the Technische Universität Dresden focus their work to optimize this manufacturing process chain. Among others their foci include:

- controlled heat input through minimization of the interaction time with simultaneously high ablation rates using ultra-short pulsed lasers
- near-net-shape processing of consolidated and unconsolidated materials using the laser remote technology (remocut®FRP)
- generation of form-fitting joints applying generating and ablative procedures
- structural adhesive bonding of composite parts
- optimized material joining of hybrid components through tailored processing of contact areas by applying laser and plasma pretreating
- generation of reactive nanometer multilayers for high speed joining processes of thermoplastic polymers
- process development to fabricate carbon fibers, which are characterized by their high resource and economic efficiency

COORDINATION

ANNETT KLOTZBACH

Phone +49 351 83391-3235

annett.klotzbach@iws.fraunhofer.de



www.iws.fraunhofer.de/composite

Thanks to the membership in the association “Carbon Composite e.V.”, the scientists benefit from a lively exchange of ideas with experts from regional enterprises and other research organizations.

The research results of several departments were successfully presented at the two international composite tradeshows “JEC” in Paris and the “Composite Europe” in Stuttgart.





MEDICAL AND BIOSYSTEMS ENGINEERING – SMART SYSTEMS

In the field of medical and biosystems engineering the laser is a firmly established tool and laser processing applications are increasingly advancing. The scientists of the Fraunhofer IWS Dresden offer a comprehensive overview about the possibilities and limits of technical systems, produced by laser technologies in the field of biotechnology, environmental biosensors and cell culture technology. New developments and industrial solutions are to be presented and explained.

Research and developments at the Fraunhofer IWS comprise a wide range of applications:

- micro structuring, cutting, drilling and joining with various short and ultra-short pulsed lasers
- design, simulation and rapid prototyping of microfluidic structures and micro reactors
- micro actuation of micro reactor technology
- generation of bio-functional / bio-compatible components (scaffolds, tissue engineering by organic printing)
- nano imprint lithography
- development of universal Lab-on-a-Chip platforms as well as 2PP-Multi-Organ-Chips

Together with their project partners Dresden scientists have implemented several products into industrial applications. These products are based on microstructural technologies and system technological approaches, which have been established at the IWS over the recent years. One example is the SPR platform for the detection of specific markers (DNA, RNA, antibodies...), which has been developed in cooperation with scientists of the Fraunhofer IOF. The microfluidic structures, applied in these measurements were designed, simulated and fabricated at the IWS.

COORDINATION

DR. UDO KLOTZBACH

Phone +49 351 83391-3252
udo.klotzbach@iws.fraunhofer.de



COORDINATION

DR. FRANK SONNTAG

Phone +49 351 83391-3259
frank.sonntag@iws.fraunhofer.de



www.iws.fraunhofer.de/biosystems

In order to meet the requirements of the pharmaceutical and cosmetics industry the IWS offers a technology platform, which is able to perform comprehensive cell culture experiments. The scientists apply a Lab-on-a-Chip system with integrated pumps for medical diagnostic and substance testing purposes. So called Multi-Organ-Chips are highly suitable for mimicking processes, taking place in a living organism. In 2012, the research into the development of an MOC platform, which might replace animal testing, was honored with the Dorothy Hegarty Award.

Apart from the Lab-on-a-Chip systems, the novel MOC technology comprises numerous additional systems for an automated operation and the non-invasive online monitoring of cell culture experiments. These systems include the actuation of the integrated micro pumps, fluorescence and optical measurement and a laboratory automated platform for precise dosage and control.

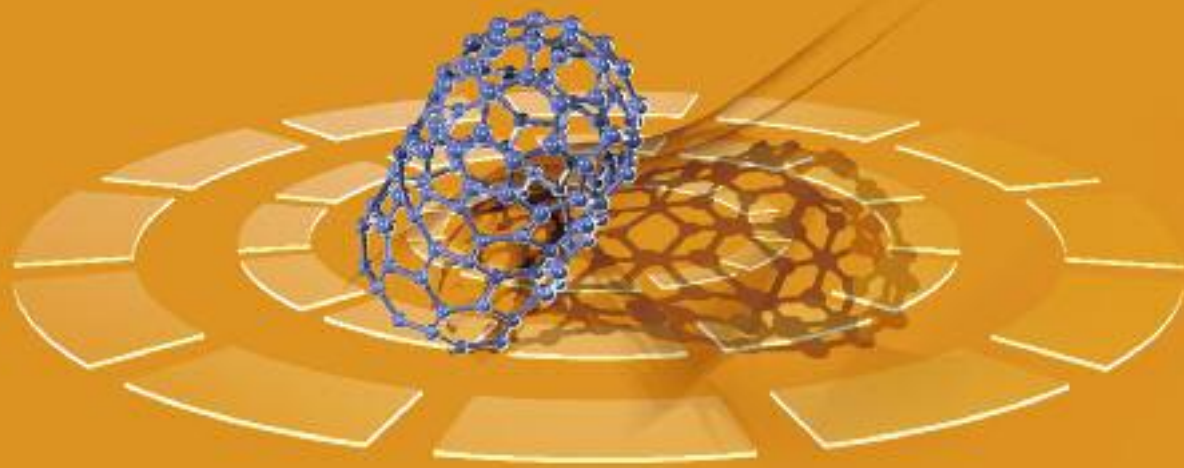

NANOTUBES AND PARTICLES – SMALL PARTS WITH GREAT EFFECT

Due to their large surfaces, nanoparticles show a different chemical and physical behavior than materials with macroscopic structures. This feature enables a decisive improvement of the characteristics of composite materials by targeted embedding nanoparticles into the corresponding matrix. The scientists of the Fraunhofer IWS focus their research on the fabrication of carbon nanoparticles and their competences comprise:

Fabrication of Single Wall Carbon Nanotubes (SWCNTs):

- development of a procedure for a scalable, cost-saving gas phase synthesis of SWCNTs, which is unique in the world
- development of an IWS pilot line for a large scale SWCNTs production (kg / day) for the fabrication of semi-conducting and metal SWCNTs with up to 90 % purity
- online monitoring of SWCNTs gas phase synthesis
- development of a process to deposit vertically aligned CNTs on surfaces (in cooperation with the TU Dresden)

Preparation of SWCNTs:

- cleaning of SWCNTs (removal of amorphous carbon and catalyst particles)
- functionalization of SWCNTs
- dispersion of SWCNTs in aqueous surfactant solutions or organic solvents for direct applications (spraying) on surfaces

Fabrication of nanoscale carbon black particles:

- development of solar thermal processes (no CO₂ emission) to fabricate carbon black of a defined structure size as a by-product of hydrogen production

COORDINATION

DR. GERRIT MÄDER

Phone +49 351 83391-3262

gerrit.maeder@iws.fraunhofer.de



www.iws.fraunhofer.de/nanoparticles

Possible applications of CNTs are:

- transparent conductive layers
- flexible conductive layers
- antistatic surfaces
- flexible conductive polymers
- optical absorbing layers

The Fraunhofer IWS is a member of the innovation alliance Inno.CNT cooperating with 90 renowned partners from science and industry. Thus the potential of SWCNTs can be perfectly utilized and transferred into industrial applications.



PROCESS MONITORING AND SENSORING – COMMITTED TO QUALITY

One central task in modern industrial production processes is to monitor the processes and to analyze the products during and after fabrication. Thus new production technologies increasingly include the development of appropriate process analytical sensors, measurement methods and devices.

The IWS center for process monitoring and sensor technology focuses on the development of optical and optical-spectroscopic sensors and their implementation in the field of laser and surface technologies.

Specially developed monitoring techniques help to derive information about laser processes (temperature, beam analysis), product characteristics (surface, layers, composition, porosity) and process atmospheres (gas composition) in a non-contact and highly sensitive manner. The results obtained are applied for automated monitoring, control and for the optimization of processes. Apart from adaptations to existing technologies, novel sensor technologies are being developed up to the point where they can be commercialized. Based on many years' experience the IWS scientists rely on their comprehensive expertise.

Foci for the monitoring of laser processes are:

- high-speed temperature monitoring of laser hardening and cladding processes (E-MAqS / E-FAqS)
- measurement and control systems for temperature monitoring (LompocPro)
- laser beam analysis for quality control of optics and laser sources (LasMon)
- plasma spectroscopy for laser welding tasks

COORDINATION

DR. WULF GRÄHLERT

Phone +49 351 83391-3406

wulf.graehlert@iws.fraunhofer.de



COORDINATION

DR. STEFFEN BONSS

Phone +49 351 83391-3201

steffen.bonss@iws.fraunhofer.de



www.iws.fraunhofer.de/processcontrol

Furthermore optical-spectroscopic procedures are applied to perform single-point measurements as well as 100 % checks. Procedures such as IR, RAMAN, UV/VIS and laser spectroscopy are excellently suited for manifold tasks in the field of process monitoring. Most modern "Hyperspectral Imaging" systems are used for a 100 % monitoring.

Development priorities for optical-spectroscopic measurement techniques are:

- optical calorimetry for the analysis of porous materials (InfraSORP®)
- determination of water vapor permeation rates of ultra-barrier materials (HiBarSens®)
- imaging analysis tools (hard and software) for Hyperspectral Imaging
- infrared based in-situ multi gas analysis (ISPRoM®)
- laser diode spectroscopic trace gas analysis (TraceScout)



DORTMUNDER OBERFLÄCHENCENTRUM (DOC®)

Surface technology is key to many steel products. ThyssenKrupp Steel Europe AG (TKSE) has concentrated its surface technology research and development efforts in Dortmund. The "Dortmunder OberflächenCentrum" (DOC® for Surface Technology Center Dortmund) is a globally leading research institution addressing the development of surface technologies for steel products. The DOC® develops tailored coatings, which are deposited in a continuous manufacturing process onto moving steel band substrates. Customer oriented development goals are the implementation of novel surface concepts leading to superior properties such as improved corrosion resistance, scratch resistance, electrical conductivity, forming capability or cleaning properties. Flat steel products with completely new functional properties and novel light-weight materials (LITECOR®) and thus increased value are also part of the current research, which for example includes work on solar thermal and photovoltaic properties.

COORDINATION

DR. AXEL ZWICK

Phone +49 231 844 3512

axel.zwick@iws.fraunhofer.de



FRAUNHOFER-PROJECTGROUP AT DORTMUNDER OBER- FLÄCHENCENTRUM DOC®

Eberhardstraße 12

44145 Dortmund

www.iws.fraunhofer.de/en/dortmund

The Fraunhofer IWS cooperates directly with DOC® by supporting a project group on site. This group works primarily on surface coatings using PVD, PACVD and spraying processes and on laser materials processing.

Current main foci in the thin film technology:

- development of conductive carbon coating systems (GLS: Graphite Like Carbon) for electromobility, e.g. for steel bipolar plates in fuel cells as well as Al and Cu electrodes for batteries and super capacitors (for example conductivity compared to gold without degradation in fuel cell stack test)
- Diamor® coating systems (ta-C: tetrahedral amorphous carbon) for wear protection based on a short pulsed arc process (spArc®) for example series implementation of self-sharpening kitchen knives
- novel PVD procedures for metal band coating processes and developments of corrosion protection properties.

They base on zinc alloy coatings, e.g. for highly corrosion-resistant metallic coatings (ZnMg) and for metallic coatings in hot forming processes (ZnFe).



Laboratory at Dortmunder Oberflächencentrum



Laser materials processing and spray coating projects include:

- development of joining processes based on laser MSG hybrid welding for lightweight construction, e.g. for the welding of mobile crane components made from high strength fine grain construction steel (19 m long hybrid welding system for longitudinal seam welding of telescopic crane parts was installed at the customer)
- high speed laser welding with high beam quality solid-state lasers and low melt particle emission,
- wire arc spraying,
- combination process of joining and wire arc spraying, e.g. for the post galvanizing of weld seams,
- development of prototype welding processes with solid-state laser.

The Fraunhofer project group offers a selection of complementary surface refinement technologies, which is available at its 1100 m² laboratory space. The latest system technology is used to make spray coatings with the cost effective wire arc process, which can also be performed in an oxygen-free environment (vacuum chamber) and in combination with solid-state lasers. Surface areas of parts and tools exposed to high wear conditions can be clad with millimeter thick wear protective coatings using laser buildup welding. Even in vacuum it is possible to coat meter-sized and ton-heavy parts with nano- and micrometer thin high performance coatings including Diamor[®] films that are deposited with the cost effective and robust spArc[®] process. These coatings have an exceptional hardness and excellent low friction properties. They are deposited at high rates and at temperatures below 150 °C. New coating material systems are under development to provide additional corrosion protection properties.

The spectrum of system technology available at the Fraunhofer DOC[®] project group includes:

- modular spArc[®] evaporator technology with industrial PVD large chamber system with a usable diameter and height of 1.2 m each (batch load up to 2 tons),
- in-house developed high performance PVD technology for the metal band coating under rough vacuum conditions,
- latest wire arc spray technology with spraying cabin, vacuum chamber and the possibility to support the process with laser power,
- 3D capable laser and laser-MSG hybrid welding system (gantry portal system, robot systems) with mobile 8 kW fiber and 4 kW Nd: YAG-lasers.

Additional systems from Fraunhofer IST and TKSE are available for joint projects. TKSE, IST and IWS jointly operate the DOC[®]'s modular and 80 m long sheet metal band coating pilot machine. The team offers research and development on vacuum coating processes for the continuous surface refinement of thin metal sheets.

The broad selection of offered processes and systems can also be efficiently combined in many instances. In combination with Fraunhofer IWS know-how we ensure that we provide TKSE, TKSE's customers and other industrial customers with technically and economically optimized solutions. New, compact and mobile solid-state lasers offer the possibility to perform process development as well as trouble shooting directly onsite and on short notice for our industrial customers.



PROJECT CENTER LASER INTEGRATED MANUFACTURING IN WROCŁAW (PCW)

The competencies of the Fraunhofer Project Center (founded in 2008) comprise the core laser based business fields of the Fraunhofer IWS:

- ablation and cutting
- joining
- surface layer technology
- thermal coating technology

and the basic areas of the CAMT (Center for Advanced Manufacturing Technologies of the Wrocław University of Technology):

- manufacturing technologies, including generative technologies
- production management
- production automation and control
- quality inspection systems

The Fraunhofer Project Center is located at the Institute of Production Engineering and Automation at the Wrocław University of Technology.

In 2013 the center intensified its efforts to establish the Fraunhofer model into the Polish research market. The scientists successfully intensified their close customer relations.

The systems, installed in 2012, for the cutting of airbag materials, the welding of plate heat exchangers and for the powder cladding technology were successfully integrated into the existing production chains in 2013.

The joint research concentrates on the implementation and optimization of the production process and on the operator's instruction and training.

EXECUTIVE DIREKTOR OF INSTITUTE

PROF. EDWARD CHLEBUS

TU Wrocław

Telefon +48 71 320 2705

edward.chlebus@pwr.wroc.pl

PROJECT CENTER LASER INTEGRATED MANUFACTURING

Wrocław University of Technology

ul. Łukasiewicza 5

50-371 Wrocław, Poland

COORDINATION

DR. JAN HAUPTMANN

Fraunhofer IWS

Phone +49 351 83391-3236

jan.hauptmann@iws.fraunhofer.de



www.iws.fraunhofer.de/poland

The existing software solutions were adapted and expanded to meet the customer's requirements. These adaptations were particularly necessary for the cutting of "One Piece Woven" airbags, since there is a continuous demand due to new designs in the automotive industry. Continual modifications require software adaptations and extensions. The remote cutting technology offers the necessary flexibility. The cooperation between the two institutes was intensified by the exchange of personnel and individual contacts strengthened the close partnership.



The new quality of the research work was the result of combining the mutual diversified competencies into joint efforts and the results of the project RemCoVIs are a striking example. Within this project new visualizations and monitoring solutions for remote cutting processes were developed and daily proved in the laboratories at the Fraunhofer IWS Dresden. The jointly achieved results were continuously improved and optimized and convinced all involved partners. Customer presentations aroused vivid interest and promising dialogues for concrete applications have started.

The project LasTech "Laser Technologies for Manufacturing Functional 3D and Surface Structures" addressed the identification of micro metallurgical parameters for laser generated parts. In the course of the project the porosity of the parts could be reduced to a 0.04 pore fraction. Further tasks aimed at minimizing the structure size to reduce post processing requirements and to improve the surface quality. The project results were implemented in "ready to use" sample components in apparatus construction and medical device technology.

The highlight of the year 2013 was the granting of an honorary doctorate title by the Wrocław University of Technology to Prof. Beyer on November 15th, 2013. The ceremony was embedded into the annual founding celebration of the Wrocław University of Technology on

November 15th 1945, whose roots lead back to the "Lemberg Polytechnika" and the "Technische Universität Breslau". In his laudation Prof. Chlebus emphasized Prof. Beyer's outstanding contribution to the research in laser materials processing and to his activities to internationalize the Fraunhofer model.

Welcoming Prof. Beyer among the particularly honored "Doctor Causa" of the TU Wrocław will intensify the successful cooperation between these two research organizations.



Prof. Dr.-Ing. habil. Eckhard Beyer (right) is awarded the honorary doctorate title by Prof. Dr.-Ing. habil. Tadeusz Wieckowski (left), Prof. Dr. Edward Chlebus (middle)



FRAUNHOFER-CENTER FOR COATINGS AND LASER APPLICATIONS (CCL)

The United States market is one of the most important global benchmarks and drives innovation with applied research and development. The Fraunhofer IWS in Dresden has therefore established US activities in the “Fraunhofer Center for Coatings and Laser Applications – CCL” since 1994. The Center reflects the main IWS activities in the business fields of laser and coatings technologies. The Center is one of the most successful Fraunhofer Centers in the USA with an annual turnover of \$5 Mio.

The CCL has two divisions, the “Coatings Technology Division”, located at Michigan State University in East Lansing, Michigan, and the “Laser Applications Division”, located in Plymouth, Michigan. The collaboration with Michigan State University started in 2003. Prof. Jes Asmussen, an internationally renowned plasma and diamond technology expert, assumed leadership of the Center. His scientific expertise at Michigan State University ideally complements IWS know-how in the area of Diamor® coatings.



Dr. Georg Rosenfeld, President of Fraunhofer USA Inc., with Prof. Eckhard Beyer, Executive Director of the Fraunhofer IWS Dresden and Dr. William Hartman, Executive Vice President and Chief Operating Officer of Fraunhofer USA (f.l.t.r.)

CENTER DIRECTOR CCL / USA

PROF. JES ASMUSSEN

Phone +1 517 355 4620
 jasmussen@fraunhofer.org
 www.ccl.fraunhofer.org



DIRECTOR COATING TECHNOLOGY DIVISION

DR. THOMAS SCHÜLKE

Phone +1 517 432 8173
 tschuelke@fraunhofer.org
 East Lansing, Michigan
 48824-1226, USA
 www.ccl-laser.fraunhofer.org



DIRECTOR LASER APPLICATIONS DIVISION

CRAIG BRATT

Phone +1 734 738 0550
 cbratt@fraunhofer.org
 Plymouth, Michigan 48170-6080, USA
 www.ccl-coatings.fraunhofer.org



In September of 2013, the Center celebrated the 10-year anniversary of the Fraunhofer-Michigan State University collaboration. The partners looked back at the collaboration’s performance and the numerous scientific and technical highlights with a sense of pride and accomplishment. In 2013 the Center acquired more than \$3 Mio. in contracts from industrial customers, which underlines the high quality of the research and development work performed at CCL.



Laser Applications Division

CCCL's Laser Applications Division is located in Plymouth, Michigan, and thus in close proximity to the American automotive industry in Detroit. The laser group has comprehensive know-how in materials processing with high power lasers. The activities focus on developing technologies such as laser beam welding and buildup welding as well as additive manufacturing for numerous customers across industries.

In 2013 many new laser applications were developed and installed in manufacturing lines. An example is a prototype machine for the repair and generation of powertrain components through 3D laser buildup welding. Another example is the installation of the inductively supported laser beam welding process for an automotive company. Engineers at the Fraunhofer IWS Dresden developed and patented this process.

In recent years lithium ion battery technology has also become a core competence at CCL. The laser group intensively develops laser beam welding technologies for various customers in this field. Several process installations were deployed in industry.

CCL's quality control management system is certified according to DIN ISO9901:2008 and guarantees documented and reproducible project performance.



Coating Technology Division

CCL's Coatings Technology Division cooperates in East Lansing with faculty members and students from the Michigan State University on developing new solutions to fabrication of diamond-like carbon coatings, polycrystalline diamond coatings and diamond crystals using PVD and CVD processes.

CCL offers the complete process chain to coat powertrain and brake components with Diamor®, which reduces CO₂ emissions and reduces the fuel consumption of vehicles. This low friction coating is made from diamond-like carbon. It is very efficiently produced at high quality using the Laser-Arc process and systems technology that was developed at the IWS Dresden.

The Fraunhofer CCL offers to its customers the design and fabrication of tailored boron-doped diamond electrodes for electrochemical applications. Such thin film electrodes have substantial cost benefits over conventional platinum electrodes. Simultaneously, these electrodes are suitable for a broader range of applications due to their wider electrochemical potential window and lower background noise level.

CCL's Coatings Technology Division is also known for their fabrication of high quality single crystalline diamond plates and crystals. Today such diamond products are produced in larger quantities and tailored to customer specifications.

NETWORKS





Joseph von Fraunhofer

THE FRAUNHOFER-GESELLSCHAFT

Research of practical utility lies at the heart of all activities pursued by the Fraunhofer-Gesellschaft. Founded in 1949, the research organization undertakes applied research that drives economic development and serves the wider benefit of society. Its services are solicited by customers and contractual partners in industry, the service sector and public administration.

At present, the Fraunhofer-Gesellschaft maintains 67 institutes and research units. The majority of the more than 23,000 staff are qualified scientists and engineers, who work with an annual research budget of 2 billion euros. Of this sum, more than 1.7 billion euros is generated through contract research. More than 70 percent of the Fraunhofer-Gesellschaft's contract research revenue is derived from contracts with industry and from publicly financed research projects. Almost 30 percent is contributed by the German federal and Länder governments in the form of base funding, enabling the institutes to work ahead on solutions to problems that will not become acutely relevant to industry and society until five or ten years from now.

International collaborations with excellent research partners and innovative companies around the world ensure direct access to regions of the greatest importance to present and future scientific progress and economic development.

With its clearly defined mission of application-oriented research and its focus on key technologies of relevance to the future, the Fraunhofer-Gesellschaft plays a prominent role in the German and European innovation process. Applied research has a knock-on effect that extends beyond the direct benefits perceived by the customer: Through their research and development work, the Fraunhofer Institutes help to reinforce the competitive strength of the economy in their local region, and throughout Germany and Europe. They do so by

promoting innovation, strengthening the technological base, improving the acceptance of new technologies, and helping to train the urgently needed future generation of scientists and engineers.

As an employer, the Fraunhofer-Gesellschaft offers its staff the opportunity to develop the professional and personal skills that will allow them to take up positions of responsibility within their institute, at universities, in industry and in society. Students who choose to work on projects at the Fraunhofer Institutes have excellent prospects of starting and developing a career in industry by virtue of the practical training and experience they have acquired.

The Fraunhofer-Gesellschaft is a recognized non-profit organization that takes its name from Joseph von Fraunhofer (1787–1826), the illustrious Munich researcher, inventor and entrepreneur.

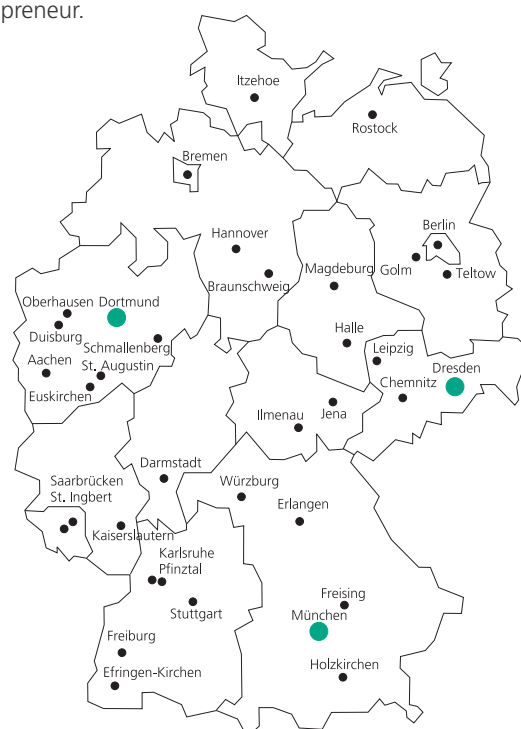



FRAUNHOFER-GROUP LIGHT & SURFACES

COMPETENCE BY NETWORKING

Six Fraunhofer institutes cooperate in the Fraunhofer Group Light & Surfaces. Co-ordinated competences allow quick and flexible alignment of research work on the requirements of different fields of application to answer actual and future challenges, especially in the fields of energy, environment, production, information and security. This market-oriented approach ensures an even wider range of services and creates synergetic effects for the benefit of our customers.

CORE COMPETENCES OF THE GROUP

- surface and coating functionalization
- laser-based manufacturing processes
- laser development and nonlinear optics
- materials in optics and photonics
- microassembly and system integration
- micro and nano technology
- carbon technology
- measurement methods and characterization
- ultra precision engineering
- material technology
- plasma and electron beam sources

CONTACT

Group Chairman
Prof. Dr. Andreas Tünnermann

Group Assistant
Susan Oxfart
phone: +49 3641 807-207
www.light-and-surfaces.fraunhofer.de

FRAUNHOFER INSTITUTE FOR ELECTRON BEAM AND PLASMA TECHNOLOGY FEP, DRESDEN

Electron beam technology, sputtering technology, plasma-activated high-rate deposition and high-rate PECVD are the core areas of expertise of Fraunhofer FEP. The business units include vacuum coating, surface modification and treatment with electrons and plasmas. Besides developing layer systems, products and technologies, another main area of work is the scale-up of technologies for coating and treatment of large areas at high productivity.

www.fep.fraunhofer.de

FRAUNHOFER INSTITUTE FOR LASER TECHNOLOGY ILT, AACHEN

Since 1985 the Fraunhofer Institute for Laser Technology ILT has developed innovative laser beam sources, laser technologies, and laser systems for its partners from the industry. Our technology areas cover the following topics: laser and optics, medical technology and biophotonics, laser measurement technology and laser materials processing. This includes laser cutting, caving, drilling, welding and soldering as well as surface treatment, micro processing and rapid manufacturing. Furthermore, the Fraunhofer ILT is engaged in laser plant technology, process control, modeling as well as in the entire system technology.

www.ilt.fraunhofer.de



FRAUNHOFER INSTITUTE FOR APPLIED OPTICS AND PRECISION ENGINEERING IOF, JENA

The Fraunhofer IOF develops solutions with light to cope foremost challenges for the future in the areas energy and environment, information and security, as well as health care and medical technology. The competences comprise the entire process chain starting with optics and mechanics design via the development of manufacturing processes for optical and mechanical components and processes of system integration up to the manufacturing of prototypes. Focus of research is put on multifunctional optical coatings, micro- and nano-optics, solid state light sources, optical measurement systems, and opto-mechanical precision systems.

www.iof.fraunhofer.de

FRAUNHOFER INSTITUTE FOR PHYSICAL MEASUREMENT TECHNIQUES IPM, FREIBURG

Fraunhofer IPM develops and builds optical sensor and imaging systems. These mostly laser-based systems combine optical, mechanical, electronic and software components to create perfect solutions of robust design that are individually tailored to suit the conditions at the site of deployment. In the field of thermoelectrics, the institute has extensive know-how in materials research, simulation, and systems. Fraunhofer IPM also specializes in thin-film technologies for application in the production of materials, manufacturing processes and systems.

www.ipm.fraunhofer.de

FRAUNHOFER INSTITUTE FOR SURFACE ENGINEERING AND THIN FILMS IST, BRAUNSCHWEIG

As an industry oriented R&D service center, the Fraunhofer IST is pooling competencies in the areas film deposition, coating application, film characterization, and surface analysis. Scientists, engineers, and technicians are busily working to provide various types of surfaces with new or improved functions and, as a result, help create innovative marketable products. The institute's business segments are: mechanical and automotive engineering, aerospace, tools, energy, glass and facade, optics, information and communication, life science and ecology.

www.ist.fraunhofer.de

FRAUNHOFER INSTITUTE FOR MATERIAL AND BEAM TECHNOLOGY IWS, DRESDEN

The Fraunhofer Institute for Material and Beam Technology is known for its innovations in the business areas joining and cutting as well as in the surface and coating technology. Our special feature is the expertise of our scientists in combining the profound know-how in materials engineering with the extensive experience in developing system technologies. Every year, numerous solution systems have been developed and have found their way into industrial applications.

www.iws.fraunhofer.de



EXCELLENT COOPERATION PARTNER TU DRESDEN

The cooperation with the TU Dresden began in 1997. Since then the Fraunhofer IWS has continuously expanded the cooperation with various university chairs. Such collaboration enables the combination of the broad basic science knowledge of the university with the applied development work performed at the IWS. Professors and coworkers at the TU Dresden are closely involved in IWS research projects and have access to the technical equipment and infrastructure at the institute. IWS management and coworkers support the university in educating students and graduate students. Junior scientists emerge from this pool. This effort is driven by these scientists:

FACULTY OF MATHEMATICS AND NATURAL SCIENCES DEPARTMENT OF CHEMISTRY AND FOOD CHEMISTRY

CHAIR OF INORGANIC CHEMISTRY
PROF. DR. RER. NAT. HABIL.
STEFAN KASKEL



Topics:

- synthesis, characterization and application of porous materials
- inorganic nanoparticles
- nanocomposites and hybrid materials

FACULTY OF MECHANICAL SCIENCE AND ENGINEERING INSTITUTE OF MANUFACTURING TECHNOLOGY

**CHAIR OF LASER AND SURFACE
TECHNOLOGY**
PROF. DR.-ING. HABIL. DR. H. C.
ECKHARD BEYER



Topics:

- laser systems technology
- laser machining processes
- plasma in manufacturing
- surface technologies
- laser robotics

FACULTY OF MECHANICAL SCIENCE AND ENGINEERING INSTITUTE OF MATERIALS SCIENCE

CHAIR OF MATERIALS SCIENCE
PROF. DR.-ING.
CHRISTOPH LEYENS



Topics:

- metallic and intermetallic high temperature materials
- ferrous and nonferrous materials
- surface and coating technologies
- relationships between microstructure and properties of metallic materials

»We all must discern, that we all must learn.«

Wilhelm Busch



**FACULTY OF MECHANICAL SCIENCE AND ENGINEERING
INSTITUTE OF MANUFACTURING TECHNOLOGY**

**PROFESSOR FOR LASER STRUCTURING IN
MANUFACTURING TECHNOLOGY**
PROF. DR.-ING.
ANDRÉS-FABIÁN LASAGNI



Topics:

- fabrication of large area 2- and 3D micro and nanostructures
- surface functionalization
- laser structuring
- two photon polymerization

**FACULTY OF MECHANICAL SCIENCE AND ENGINEERING
INSTITUTE OF MATERIALS SCIENCE**

**PROFESSOR FOR MATERIALS TESTING AND
CHARACTERIZATION**
PROF. DR.-ING.
MARTINA ZIMMERMANN



Topics:

- mechanical properties and microstructure
- fatigue (high frequency test engineering)
- failure analysis and prevention
- structure and component reliability

**FACULTY OF MECHANICAL SCIENCE AND ENGINEERING
INSTITUTE OF MANUFACTURING TECHNOLOGY**

**PROFESSOR FOR NANO- AND COATING
TECHNOLOGY**
PROF. DR. RER. NAT.
ANDREAS LESON



Topics:

- nanotechnology
- thin film technology

**FACULTY OF MECHANICAL SCIENCE AND ENGINEERING
INSTITUTE OF MANUFACTURING TECHNOLOGY**

**PROFESSOR FOR PRODUCTION
TECHNOLOGY STEINBEIS UNIVERSITY**
PROF. DR.-ING.
ULRICH GÜNTHER



Topics:

- surface cutting
- production design



»DRESDEN INNOVATION CENTER ENERGY EFFICIENCY DIZE^{EFF}«

In 2009 the TU Dresden together with the Fraunhofer Society founded the Dresden Innovation Center Energy Efficiency DIZE^{EFF} as part of the DRESDEN-concept network.

The innovation center's goals are:

- to expand the Dresden region's efforts in the key future topic "energy efficiency" beyond the existing institutional borders,
- to accelerate innovation at local industry
- to promote the development of young researchers by focusing university education and making the region more attractive to prospective students.

A total of 9 TU Dresden institutions and 4 Fraunhofer institutes collaborate on 23 scientific projects to address the following areas:

- high performance solar cells,
- fuel cells,
- high temperature energy technology,
- light weight construction and energy efficient manufacturing,
- energy saving displays.

SPEAKER

PROF. ECKHARD BEYER

Phone +49 351 83391-3420
eckhard.beyer@iws.fraunhofer.de



COORDINATION

DR. STEFAN SCHÄDLICH

Phone +49 351 83391-3411
stefan.schaedlich@iws.fraunhofer.de



www.innovation-energieeffizienz.de

Fraunhofer contributed six million Euros over four years for the first project phase. The Free State of Saxony and the "European Funds for Regional Development" (EFRE) provided an additional four million. The project results are now compiled in a brochure.

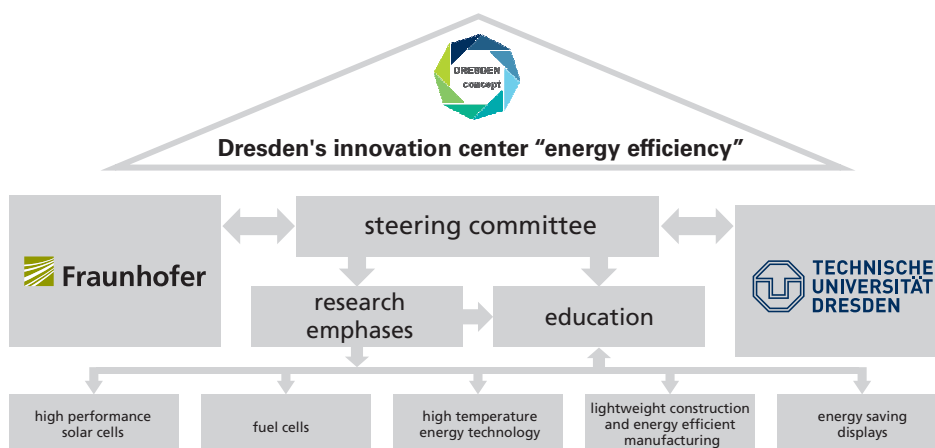



After four years of activity DIZE^{EFF} is recognized as a successful effort both scientifically and economically. DIZE^{EFF} scientists participated in research on organic electronics. An example is the project-overarching research work performed by the groups of Prof. Dr. Lasagni and Dr. Mueller-Meskamp. They developed technologies for the rapid and large area fabrication of nanostructures for highly efficient solar cells. The teams received the German High Tech Champions Award for their success in the field of solar / PV.

The success of DIZE^{EFF} can also be evaluated by the center's acquisition of third party revenues. At the end of the project, total third party revenues amounted to 130 % of the internally contributed funding. These additional funds helped to create new and maintain existing jobs for scientists in Dresden.

The effort's educational component was also very successful. The TU Dresden has offered the discipline "Regenerative Energy Systems" since the winter semester of 2011, which involves several DIZE^{EFF} related professorships. Students are comprehensively exposed to current research projects. Examples of this include the cost effective production of solar cells, energy saving displays and new materials for fuel cells. In addition, numerous Fraunhofer scientists are involved in teaching activities at the TU Dresden.

Another example for the success of this research collaboration in the Dresden region is the conference "Future Energy", which was held for the second time in 2013. Fraunhofer IWS and partners from DRESDEN-concept organized the conference. The conference features 30 national and international speakers as well as numerous exhibitors showing novel developments and visions in areas such as thermo-electrics, solar thermal systems, photo voltaic systems, energy storage, mobility, fuel cells and energy efficiency.

The 3rd Dresden Conference "Future Energy" is already planned for May 5th - 6th 2015 and will be held in the International Congress Center Dresden. For more information please refer to www.zukunftenergie-dresden.de

These Dresden research activities were also promoted with a joint trade show booth at the Hannover Fair Industry (see figure above).



TU institutes

	Fraunhofer institutes	Material and beam technology	Electron beam and plasma technology	Ceramic technologies and systems	Photonic microsystems
Manufacturing technology		<input type="checkbox"/>			
Inorganic chemistry		<input type="checkbox"/>		<input type="checkbox"/>	
Applied physics			<input type="checkbox"/>	<input type="checkbox"/>	<input type="checkbox"/>
Materials science				<input type="checkbox"/>	
Lightweight construction and polymer technology		<input type="checkbox"/>			
Semiconductor and microsystems technology					<input type="checkbox"/>
Electronic packaging laboratory					<input type="checkbox"/>
Solid-state electronics			<input type="checkbox"/>		
Power engineering			<input type="checkbox"/>	<input type="checkbox"/>	

Network for Fraunhofer institutes and institutions of the TU Dresden



SPECIAL EVENTS

JANUARY 23rd - 24th 2013

Modular seminary series "Strong Products through Thin Coatings" innovations with thermal spray coating technologies in Dresden (organizer: OTTI East Bavarian Technology Transfer Institute e.V. Regensburg)

FEBRUARY 5th - 6th 2013

2nd Conference on Lightweight Design "Laser Technology in Lightweight Design" in Dresden (organizer: Fraunhofer Alliance Lightweight Design)

MARCH 13th - 14th 2013

Modular seminary series "Strong Products through Thin Coatings" innovations with arc and evaporation technologies in Dresden (organizer: OTTI East Bavarian Technology Transfer Institute e.V. Regensburg)

APRIL 10th - 11th 2013

TAW Symposium "Thermal Coating with Laser Based Manufacturing Processes", Technical Academy Wuppertal e.V. in collaboration with the Fraunhofer IWS Dresden and the FriBa Lasernet Holzkirchen in Dresden

APRIL 25th 2013

Fraunhofer Institutes Center participates in federal "Girls Day" activities

MAY 28th - 29th 2013

2nd Dresden Symposium "Future Energy" at the International Congress Center in Dresden (organizer: Fraunhofer IWS Dresden)

JULY 5th 2013

Fraunhofer IWS Dresden participates in the "Long Night of the Sciences" of the state capital Dresden

AUGUST 26th - 30th 2013

2nd International Summer School "Trends and New Developments in Laser Technology" (organizer: Fraunhofer IWS Dresden)

SEPTEMBER 16th 2013

10th Anniversary of the Fraunhofer CCL (IWS extension) cooperation with Michigan State University in East Lansing (organizer: Fraunhofer CCL)

OCTOBER 8th - 9th 2013

Tutorial "Amorphous Carbon Coatings" at the Fraunhofer IWS Dresden (organizer: EFDS European Research Society Thin Films e.V.)

NOVEMBER 6th - 7th 2013

2nd Workshop "Lithium-Sulfur Batteries" at the Fraunhofer IWS Dresden (organizer: Fraunhofer IWS Dresden and Institut für Anorganische Chemie der TU Dresden)

NOVEMBER 11th 2013

Green Day "Schools Check Out Green Jobs" (organizer: Zeitbild Foundation)

NOVEMBER 28th 2013

"Alberta-Germany Collaboration Fund" Symposium (organizer: Saxony Economic Development Corporation)

AWARDS AND HONORS



Prof. Dr.-Ing. habil. Eckhard Beyer, head of the Fraunhofer IWS Dresden and director of the Institute of Manufacturing Technology at the TU Dresden, was awarded an honorary doctorate by the Wrocław University of Technology on November

15th, 2013. Honored were his excellent scientific achievements in the field of laser technologies and his extraordinary engagement to form a joint education and research center with Wrocław University of Technology.



Mrs. **Annett Klotzbach** (2nd from left) and her team colleagues **Andreas Fuerst** (1st from left), **Frank Kretzschmar** (2nd from right) and **Karsten Zenger** (1st from right) received the title German High Tech

Champion (GHTC®) from the Fraunhofer-Gesellschaft. The award in the category "Lightweight Design" was given to the team for their work on laser remote processing of fiber reinforced composite materials. Mrs. Klotzbach and her team developed a technology, which is an important stepping-stone toward efficient weight reduction of vehicles and consumer products by means of fiber reinforced composite materials. Various textiles and composite components can be structured, cut, activated or repaired with the help of brilliant laser beam sources, novel software modules and modern image processing systems. The GHTC® award is a part of the BMBF funded project "International research marketing". The project markets Germany's strength as a research location with the goal to hone the country's profile within the international science market.



Prof. Dr. Andrés Fabián Lasagni, Professor for Laser Structuring at the Institute for Manufacturing Technology of the TU Dresden and head of the surface functionalization research group at the Fraunhofer IWS Dresden (right

in picture), received the Masing Memorial Prize from the German Society of Materials Sciences (DGM) for his successes in applying laser technology in materials sciences. His research focuses on advancing laser-based structuring technologies to fabricate complex micro and nanostructures across large surface areas. DGM members bestow the Masing Memorial Prize for independent research results in materials sciences.

In 2013 the Dorothy Hegarty Award 2012 was bestowed upon **Dr. Frank Sonntag** (staff member of the microstructuring research group at Fraunhofer IWS), **Dr. Udo Klotzbach** (head of the same group) as well as a team of biologists and physicians. The award acknowledges the team's work in the field of biosystems technologies, which aims at reducing or even avoiding the need for animal testing. The Dorothy Hegarty Award is annually issued by the international peer reviewed science journal "Alternatives to Laboratory Animals (ATLA)".

Mr. **Sebastian Eckhardt** achieved 3rd place in a competition for the "Green photonics prize for young talents" with his diploma thesis on "Direct laser interference structuring of ZnO and PET substrates to improve efficiency". The technology improved the efficiency of organic solar cells by approximately 20 %. This Young Talent Prize is awarded to young scientists who research topics in light, optics, and photonics for environmental protection, climate change mitigation and resource conservation.



On December 19th IWS prizewinners of the year 2013 received their award.

Dr. Harald Beese and Mr. **Oliver Throl** received an award to honor their outstanding scientific technical performance developing and commercializing a measurement system to reliably determine the water vapor transmission rates of barrier materials. The system relies on laser diode spectroscopy to improve the detection limit for water vapor transmission by two orders of magnitude to $10^{-6} \text{ g m}^{-2} \text{ d}^{-1}$. The system is capable of measuring ultrabARRIER materials for applications in organic electronics. First units are successfully deployed in industry.

Ms. **Juliane Fichtner** was recognized as an outstanding student performer for her research on "Fabrication and characterization of a printable carbon nanotube polymer paste". Her researches focused on the fabrication of the paste and on rheological studies to simulate mechanical loads during dispense printing. The results are the basis for many projects in the field of 3D printing. Mr. **Dimitri Benke** delivered another outstanding student performance. He developed a laser interference processing head for direct holographic structuring. High complexity and counterfeit protection as well as numerous design possibilities of the motives generated make the process and the processing head of interest to industrial applications.

Mr. **Adam Kubec** received the award for the best performance of a young scientist. He delivered an important contribution to focus hard X-ray radiation with multilayer Laue lenses. The merit of his contribution lies especially in the simulation of the coating processes in combination with characterizing the optical properties of the created multilayer Laue lenses. Only after few optimizations during the fabrications process, experiments with two crossed multilayer Laue lenses showed at 20 keV X-ray energy a focal point area of $39 \times 49 \text{ nm}^2$ and a diffraction efficiency of about 12 % (pages 50/51).

The award for the innovative product idea to launch a new business field went to Mr. **Rene Siebert**. He searched for possibilities to improve the efficiency of electromotors and established a corresponding laser process. The laser process treats the electrical steel laminations used in electromotors. Such laminations have a randomized grain orientation and the laser treatment causes thermally induced changes of intrinsic stresses in the material. The surface treatment is tailored to the application and affects the magnetic flux in components made from soft magnetic materials. The magnetic efficiency of the component is significantly increased.

The special prize of the institute went to trainees in the field of materials testing. **Nadine Böhme, Clemens Grahl, Sten Kühne** and **Enrico Rehn** were recognized for their extraordinary engagement in microstructural and mechanical materials testing.



Anja Techel, Rene Siebert, Andreas Leson, Dimitri Benke, Eckhard Beyer, Adam Kubec, Juliane Fichtner, Harald Beese, Nadine Böhme, Sten Kühne, Andrea Ostwaldt, Clemens Grahl, Enrico Rehn (f.l.t.r)

PUBLICATIONS

PRP= peer-reviewed papers

[L1]

D. Acevedo, H. Salavagione, A.-F. Lasagni, E. Morallón, F. Mücklich, C. Barbero

»SERS Active Surface in Two Steps, Patterning and Metallization«

Advanced Engineering Materials 15 (2013), Nr. 5, S. 325-329
DOI: 10.1002/adem.201200240

[L2]

M. Andrich

»Characterisation of the Friction and Wear Behaviour of Textile Reinforced Polymer Composites in Contact with Diamond-Like Carbon Layers«

Tribology International 62 (2013), S. 29-36

[L3]

L.-M. Berger, M. Barbosa, H.-P. Martin, R. Puschmann, S. Scheitz, S. Thiele, C. Leyens, E. Beyer, A. Michaelis

»Potential of Thermal Spray Technologies for the Manufacture of TEG«

Thermoelectrics goes Automotive, 21.-23.11.2012, Berlin, Tagungsband, 2013, S. 260-272
ISBN: 978-3-8169-3169-0

[L4]

E. Beyer, A. Mahrle

»High-Power Laser Materials Processing«

LIA Today 21 (2013), Nr. 5, S. 12-15

[L5]

M. Bieda, C. Schmädicke, A. Wetzig, A. Lasagni

»Direct Laser Interference Patterning of Planar and Non-Planar Steels and their Microstructural Characterization«

Metals and Materials International 19 (2013), Nr. 1, S. 81-86
DOI: 10.1007/s12540-013-1013-6

[L6]

S. Bonß, B. Brenner, F. Tietz, E. Beyer

»Laser Heat Treatment Technologies for Wear Protection of Steam Turbine Blades«

6th International Congress on Laser Advanced Materials Processing, 23.-26.07.2013, Niigata, Japan, Tagungsband, #13-109

[L7]

J. Bretschneider, G. Kirchhoff, M. Zimmermann, U. Stamm, J. Standfuß, B. Brenner

»Schwingfestigkeit laserstrahlgeschweißter Rundnähte unter mehrachsiger Belastung«

Werkstoffprüfung 2013, 28.-29.11.2013, Neu-Ulm, Tagungsband

[L8]

F. Brückner, D. Lepski, S. Nowotny, C. Leyens, E. Beyer

»Simulation of Stress and Strain of Multi-Track Formations in (Induction-Assisted) Laser Cladding«

Laser Applications in Industry, 19.-20.03.2013, Pilsen, Tschechien, Tagungsband

[L9]

F. Brückner, M. Riede, S. Nowotny, F. Kubisch, C. Leyens, E. Beyer

»Surface Functionalization by High-precision Laser Cladding: Process Equipment and Manufacturing Strategies for Miniaturized and Customized Components«

Laser Technik Journal, 10 (2013), Nr. 1, S. 29-31
ISSN: 1613-7728

[L10]

F. Brückner, M. Riede, T. Finaske, S. Nowotny, C. Leyens, E. Beyer

»Laser-Based Generation of Precise Functional Structures and Components«

32nd International Congress on Applications of Lasers and Electro Optics, 6.-10.10.2013, Miami, USA, Tagungsband, Paper 1202, S. 312-317
ISBN: 978-0-912035-98-7

[L11]

F. Brückner, T. Finaske, M. Riede, S. Nowotny, C. Leyens

»Laser Additive Manufacturing and Repair of Jet Engine Components«

Turbine Forum 2013, Effective Repair & Life Extension of Turbine Components, 24.-26.04.2013, Nice - Port St. Laurent, France, Tagungsband

[L12]

J. Brückner, S. Thieme, F. Böttger-Hiller, I. Bauer, H. Tamara Grossmann, P. Strubel, H. Althues, S. Spange, S. Kaskel

»Carbon-Based Anodes for Lithium Sulfur Full Cells with High Cycle Stability«

Advanced Functional Materials (2013)
DOI: 10.1002/adfm.201302169

[L13]

M. Busek, M. Nötzel, C. Polk, F. Sonntag

»Characterization and Simulation of Peristaltic Micropumps«

Journal of Sensors and Sensor Systems 2 (2013), S. 165-169
DOI: 10.5194/jsss-2-165-2013

[L14]

M. Cremer, M. Zimmermann, H.-J. Christ

»High-Frequency Cyclic Testing of Welded Aluminium Alloy Joints in the Region of Very High Cycle Fatigue (VHCF)«

International Journal of Fatigue 57 (2012), S. 120-130
ISSN: 0142-1123

[L15]

M. Cremer, M. Zimmermann, H.-J. Christ

»Hochfrequente Ermüdungsprüfung geschweißter Aluminiumproben bis in den Bereich sehr hoher Lastspielzahlen«

Werkstoffprüfung 2013, 28.-29.11.2013, Neu-Ulm, Tagungsband

[L16]

I. Dani, A. Roch, L. Stepien, C. Leyens, M. Greifzu, M. v. Lukowicz

»Energy Turnaround: Printing of Thermoelectric Generators«

Digital Product and Process Development Systems, IFIP TC 5 International Conference, NEW PROLAMAT 2013, Dresden, 10.-11.10.2013, Tagungsband, S. 181-184
ISBN: 978-3-642-41328-5, 978-3-642-41329-2
DOI: 10.1007/978-3-642-41329-2_19

- [L17]**
I. Dani, A. Roch, L. Stepien, C. Leyens, M. Greifzu, M. v. Lukowicz
»Energy Turnaround: Printing of Thermoelectric Generators«
G.L. Kovács and D. Kochan (Eds.): NEW PROLAMAT 2013, IFIP AICT 411, pp. 181–184, 2013. © IFIP International Federation for Information Processing 2013
- [L18]**
I. Dirnstorfer, F. Brenner, D. Simon, T. Mikolajick, N. Schilling, U. Klotzbach
»Feasibility Study for Silicon Heterojunction Metal Wrap through (SHJ-MWT) Solar Cells«
28th European Photovoltaic Solar Energy Conference and Exhibition, 30.09.-04.10.2013 Paris, Frankreich, Tagungsband, S. 1108-1112 ISBN: 3-936338-33-7
DOI: 10.4229/28thEUPVSEC2013-2BV.1.20
- [L19]**
D. Dittrich, B. Brenner, J. Standfuß
»Development of Light Weight - High Strength Alloy Fuselage Panels for Laser Beam Welding«
3rd EASN Association International Workshop on aerostructures, 09.-11.10.2013, Milan, Italien, Tagungsband
- [L20]**
D. Dittrich, B. Brenner, R. Scheidewy, E. Beyer
»Laser-Multi-Pass-Narrow-Gap-Welding of 50 mm Thick Steel or Aluminum Plates«
6th International Congress on Laser Advanced Materials Processing, 23.-26.07.2013, Niigata, Japan, Tagungsband, # 13-104
- [L21]**
D. Dittrich, B. Brenner, R. Scheidewy, E. Beyer
»Laser-Multi-Pass-Narrow-Gap-Welding of Hot Crack Sensitive Thick Al-Plates«
Lasers in Manufacturing, 13.-16.05.2013, München, Physics Procedia 41 (2013), S. 225-233 ISSN: 1875-3892
- [L22]**
D. Dittrich, B. Brenner, R. Scheidewy, J. Standfuß
»Laser-Mehrlagen-Engstspalt-schweißen zum heißrisssfreien Fügen von Aluminium-Legierungen im Dickblechbereich«
9. Internationale Konferenz »Strahltechnik«, 24.-25.04.2013, Halle (Saale), Tagungsband, S. 71-77
- [L23]**
T. Druwe, M. Milbrandt, O. Zimmer, F. Kaulfuß
»Beschichtungen für Umformwerkzeuge - Reibungs- und Verschleißuntersuchungen«
V2013 Industrieausstellung & Workshop-Woche Vakuumbeschichtung und Plasmaoberflächentechnik, 14.-17.10.13, Dresden, Tagungsband, S. 71
- [L24]**
S. Eckhardt, C. Sachse, A.-F. Lasagni
»Light Management in Transparent Conducting Oxides by Direct Fabrication of Periodic Surface Arrays«
Lasers in Manufacturing, 13.-16.05.2013, München, Physics Procedia 41 (2013), S. 545-550
DOI: 10.1016/j.phpro.2013.03.115
- [L25]**
S. Eckhardt, J. Berger, S. Schubert, A. Lasagni
»Production of Functionally Patterned Transparent Thin Film for Advanced Electrodes«
Euromat 2013, 8.-13.09.13, Seville, Spanien, Tagungsband
- [L26]**
S. Eckhardt, T. Roch, C. Sachse, A. Lasagni
»Light Management of Aluminum Doped Zinc Oxide Thin films by Fabricating Periodic Surface Textures Using Direct Laser Interference Patterning«
Advanced Engineering Materials 15 (2013), Nr. 10
DOI: 10.1002/adem.201300007
- [L27]**
M. Falz
»The LAM Family – Tools for Production of ta-C Coatings with Excellent Properties«
40th International Conference on Metallurgical Coatings and Thin Films, 29.04.-03.05.2013, San Diego, California
ISSN: 0257-8972
- [L28]**
M. Falz, M. Holzherr, H.-J. Scheibe, A. Leson, F. Geißler, M. Schulze
»Diamantharte Schichten - erfolgreich realisiert von Dresdner Kooperationspartnern«
V2013 Industrieausstellung & Workshop-Woche Vakuumbeschichtung und Plasmaoberflächentechnik, 14.-17.10.13, Dresden, Tagungsband, S. 57
- [L29]**
R. Frenzel, I. Jansen, T. Schiefer, A. Calvimontes, F. Simon
»Polyelektrolyte als Haftvermittler auf Laser strukturierten Aluminiumoberflächen«
9. Thementage Grenz- und Oberflächentechnik und 9. Thüringer Biomaterial-Kolloquium 2013, Zeulenroda 03.-05.09 2013, S. 61-65, Tagungsband
ISBN: 978-3-00-042609-4
- [L30]**
R. Frenzel, T. Schiefer, I. Jansen, A. Calvimontes, F. Simon
»Laser trifft Polyelektrolytadsorption«
Adhäsion KLEBEN & DICHTEN 57 (2013), Nr. 12, S. 40–46
- [L31]**
C. Fuchs, T. Schwab, T. Roch, S. Eckhardt, A.-F. Lasagni, S. Hofmann, B. Lüsse, L. Müller-Meskamp, K. Leo, M. C. Gather, R. Scholz
»Quantitative Allocation of Bragg Scattering Effects in Highly Efficient OLEDs Fabricated on Periodically Corrugated Substrates«
Optics Express 21 (2013), Nr. 14, S. 16319-16330
DOI: 10.1364/OE.21.016319
- [L32]**
A. Fürst, A. Klotzbach, A. Lasagni, J. Hauptmann, E. Beyer
»Laser Processing of Polymers and Reinforced Plastic Materials«
10th International Conference Advance in Plastics Technology APT' 13, 8.-10.10.2013, Sosnowiec, Polen, Paper 34
- [L33]**
A. Fürst, A. Klotzbach, R. Zocher, T. Blum, F. Kretzschmar, K. Zenger
»Investigations on the Influence of Laser Irradiation to Crimping- and Shrinkage-Effects of Thermoplastic Monofilaments«
13th Autex World Textile Conference, 22.-24.05.2013, Dresden, Tagungsband
- [L34]**
A. Fürst, A. Klotzbach, S. Hühne, J. Hauptmann, E. Beyer
»Remote Laser Processing of Composite Materials with Different Opto-Thermic Properties«
WLT-Konferenz Lasers in Manufacturing LiM 2013, Physics Procedia 41 (2013), S. 382-391
DOI: 10.1016/j.phpro.2013.03.093
- [L35]**
G. Göbel, A. Grimm, S. Schulze, E. Beyer
»Tailored Joining - Das Rührreißschweißen im Kontext moderner Fügeverfahren«
6. FSW Workshop »Rührreißschweißen und verwandte Verfahren«, 07.-08.02.2013, Geestacht, Tagungsband, S. 66-79
- [L36]**
S. Günther, R. Siebert, E. Beyer, W. Hofmann
»Einfluss der Bearbeitung von Elektrotroblechen auf die Verluste elektrischer Fahrmotoren«
Elektromobilitätsausstellung und Fachtagung zum Thema Elektromobilität, 21.-22.09.2012, Nürnberg, Tagungsband (ETG-FB 135) und Tagungs-CD
ISBN 978-3-8007-3497-9
- [L37]**
J. Hauptmann, A. Klotzbach, K. Zenger, T. Schwarz, P. Rauscher, F. Klenke
»Generative Manufacturing and Repair of Metal Parts through Direct Laser Deposition Using Wire Material«
Digital Product and Process Development Systems, IFIP TC 5 International Conference, NEW PROLAMAT 2013, Dresden, 10.-11.10.2013, Tagungsband, S. 185–189
ISBN: 978-3-642-41328-5, 978-3-642-41329-2
DOI: 10.1007/978-3-642-41329-2_20
- [L38]**
J. Hauptmann, A. Klotzbach, K. Zenger, T. Schwarz, P. Rauscher, F. Klenke
»Generative Manufacturing and Repair of Metal Parts through Direct Laser Deposition Using Wire Material«
G.L. Kovács and D. Kochan (Eds.): Digital Product and Process Development Systems, IFIP AICT 411, S. 185-189, SPRINGER-Verlag
ISBN: 978-3-642-41328-5

[L39]

P. Herwig, J. Hauptmann

»Aberrations Induced by High Brightness Lasers«

The 14th Nordic Laser Materials Processing Conference, 26.-28.08.2013, Gothenburg, Schweden, Tagungsband, S. 359-368
ISBN: 978-91-7439-688-1, 978-91-7439-689-8

[L40]

P.-M. Hilgendorff, A. Grigorescu, M. Zimmermann, C.-P. Fritzen, H.-J. Christ

»Simulation of Irreversible Damage Accumulation in the Very High Cycle Fatigue (VHCF) Regime Using the Boundary Element Method«

Materials Science and Engineering: A, 575 (2013), S. 169-176
ISSN: 0921-5093

[L41]

P.-M. Hilgendorff, A. Grigorescu, M. Zimmermann, C.-P. Fritzen, H.-J. Christ

»The Effect of Damage Accumulation in Slip Bands on the Resonant Behavior in the Very High Cycle Fatigue (VHCF) Regime«

13th International Conference on Fracture, 16.-21.05.2013, Beijing, China, Tagungsband und Tagungs-CD

[L42]

A. Jahn, J. Standfuß

»Restverformungsvermögen umgeformter und anschließend geschweißter Karosseriestähle«

Automotive Circle »International Materials in Car Body Engineering«, 07.-08.05.2013, Bad Nauheim, Tagungsband, S. 95-109

[L43]

A. Jahn, M. Wagner, J. Standfuß, J. Liebscher, R. Schedewy

»Laserstrahlgewweißte Integralstrukturen für den Schienenfahrzeugbau«

10. Fachtagung »Fügen und Konstruieren im Schienenfahrzeugbau«, 14.-15.05.2013, Halle, Tagungsband, S. 91-96

[L44]

J. Kaspar, J. Bretschneider, S. Bonß, B. Brenner

»Laser Gas Assisted Nitriding of Titanium Alloys«

LightMat 2013, 03.-05.09.2103, Bremen, Tagungsband

[L45]

F. Klaufuß, O. Zimmer

»Preparation of Sharp Cutting Edges by Coating Processes in Nanostructured AlCrN Based Films«

40th International Conference on Metallurgical Coatings and Thin Films, 29.04.-03.05.2013, San Diego, Californien, USA
ISSN: 0257-8972

[L46]

F. Klenke, J. Hauptmann

»Application of High Dynamic Processing Heads for Laser Cutting«

The 14th Nordic Laser Materials Processing Conference, 26.-28.08.2013, Gothenburg, Schweden, Tagungsband, S. 339-346
ISBN: 978-91-7439-688-1, 978-91-7439-689-8

[L47]

A. Klotzbach, A. Fürst

»Remote Laser Cutting of Near-Net-Shape & Fibre-Reinforced Part«

Industrial Laser Solutions, Juli/August 2013, S. 26-28

[L48]

A. Klotzbach, A. Fürst, F. Kretzschmar, K. Zenger, J. Hauptmann, E. Beyer

»Investigations of Multi-Wavelengths Treatment at Composite Materials«

32nd International Congress on Applications of Lasers and Electro Optics, 6.-10.10.2013, Miami, USA, Tagungsband, Paper 1906, S. 566 – 570
ISBN: 978-0-912035-98-7

[L49]

A. Klotzbach, A. Fürst, J. Hauptmann, E. Beyer

»Remote Laser Processing Fibre-Reinforced Structures«

The Laser User Issue 70, Summer 2013, S. 26-27

[L50]

A. Klotzbach, A. Fürst, M. Kempe, J. Hauptmann, E. Beyer

»Investigations on Laser Remote Cutting of Tailored Fiber Reinforced Structures«

2nd International Symposium on Laser Processing for CFRP and Composite Materials (LPCC2013), 23.-25.04.2013, Yokohama, Japan, Tagungsband

[L51]

T. Köckritz, I. Jansen, A. Richter

»Application of Carbon Nanotubes in the Field of Electroactive Polymers and their Usability for Actuators and Sensors«

6th International Conference on Carbon NanoParticle Based Composites, 22.-25.09.2013, Dresden, Tagungsband, S.49
ISBN: 978-3-9816007-0-4

[L52]

T. Köckritz, T. Schiefer, I. Jansen, E. Beyer

»Improving the Bond Strength at Hybrid-Yarn Textile Thermoplastic Composites for High-Technology Applications by Laser Radiation«

International Journal of Adhesion and Adhesives 46 (2013), S. 85–94
ISSN: 0143-7496

[L53]

A. Kolyshkin, M. Zimmermann, E. Kaufmann, H.-J. Christ

»Untersuchung der Rissinitiierung und -ausbreitung mittels des Fernfeldmikroskops im VHCF-Bereich«

Werkstoffprüfung 2013, 28.-29.11.2013, Neu-Ulm, Tagungsband

[L54]

A. Kolyshkin, M. Zimmermann, E. Kaufmann, H.-J. Christ

»Development of a Fatigue Life Prediction Concept in the Very High Cycle Fatigue Range based on Microstructural Features«

13th International ASTM/ESIS Symposium on Fatigue and Fracture Mechanics, 13.-15.11.2013, Jacksonville, USA, Tagungsband

[L55]

L. Kotte

»Oberflächenmodifizierung zur Haftvermittlung - Plasmabehandlung bei Atmosphärendruck«

Galvanotechnik (2013) 104. Band, S. 2361-2364
ISSN: 0016-4232

[L56]

L. Kotte, G. Mäder, J. Roch, B. Leupolt, S. Kaskel, J. Wielant, T. Mertens, F. J. Gammel

»Großflächige Plasmavorbehandlung und PECVD bei Atmosphärendruck mittels LARGE-Plasmaquelle«

Galvanotechnik (2013) 104. Band, S. 1742-1753

[L57]

L. Kotte, H. Althues, G. Mäder, J. Roch, S. Kaskel, I. Dani, T. Mertens, F. J. Gammel

»Atmospheric pressure PECVD based on a linearly extended DC arc for adhesion promotion applications«

Surface & Coatings Technology (2013), <http://dx.doi.org/10.1016/j.surfcoat.2013.06.070>

[L58]

S. Kuehn, S. Bonß, J. Hannweber, U. Karsunke, D. Poegen, B. Brenner, E. Beyer

»Laser Technologies in Car Body Tool Manufacturing«

6th International Congress on Laser Advanced Materials Processing, 23.-26.07.2013, Niigata, Japan, Tagungsband #13-110

[L59]

D. Langheinrich, L.R.X. Cortella, E.F. de Sá, H.T. Oyama, I.A. Cestari, I.N. Cestari, A. Lasagni

»Stem Cell Adhesion and Orientation on Laser Treated Polyurethane for Ventricular Assist devices«

Euromat 2013, 08.-13.09.13, Seville, Spanien, Tagungsband

[L60]

D. Langheinrich, R. Helbig, C. Werner, A. Lasagni

»Initial Bacterial Adhesion on Structured Polymer Surfaces Inspired by Collembolan Skin«

Euromat 2013, 08.-13.09.13, Seville, Spanien, Tagungsband

[L61]

A. Lasagni

»Direkte Laserinterferenz-Strukturierung zur effizienten Herstellung holografischer Prägestempel«

Photonik 2/2013, S.8

[L62]

A. Lasagni, S. Eckhardt, J. Berger, D. Benke

»Direct Laser Interference Patterning, a New Tool for Large Area Surface Functionalization of Flexible Materials«

Pro-Flex 2013, 24.-25.09.2013, Dresden

- [L63]**
A. Lasagni, S. Eckhardt, Y. Hyun Kim, C. Sachse, S. Hofmann, R. Scholz, L. Müller-Meskamp, K. Leo
»Lichtmanagement durch direkte Laserinterferenzstrukturierung von ZnO- und PET-Oberflächen«
OLED & Organische Elektronik, 04.-05.09.13, Dresden, Tagungsband
- [L64]**
A. Lasagni, T. Roch, M. Bieda, S. Eckhardt, D. Langheinrich, J. Berger, H. Perez, D. Benke, A. Wetzig, E. Beyer
»Pimp my Surface: Using Direct Laser Interference for High Speed Surface Functionalization«
Euromat 2013, 8.-13.09.13, Seville, Spanien, Tagungsband
- [L65]**
J. T. Lee , Y. Zhao , S. Thieme , H. Kim , M. Oschatz , L. Borchardt , A. Magasinski, W. I. Cho , S. Kaskel , and G. Yushin
»Sulfur-Infiltrated Micro- and Mesoporous Silicon Carbide-Derived Carbon Cathode for High-Performance Lithium Sulfur Batteries«
Advanced Materials (2013)
DOI: 10.1002/adma.201301579
- [L66]**
A. Leson
»Initiative »Nano in Germany««
BMBF-Broschüre nano.DE-Report, 2013
- [L67]**
C. Leyens, F. Brückner, T. Finaske, S. Thieme, S. Nowotny, E. Beyer
»Laser-Based Fabrication with Ti- and Ni-Base Superalloys«
32nd International Congress on Applications of Lasers and Electro Optics, 6.-10.10.2013, Miami, USA, Tagungsband, Paper 1201, S. 307 – 311
ISBN: 978-0-912035-98-7
- [L68]**
M. Lütke, A. Wagner, A. Wetzig
»Identification and Characterization of Analogies of Remote Fusion Cutting Processes Using Different Beam Sources«
Tagungsband 6. TAW-Syposium »Thermisches Beschichten«, 10.-11.04.2013, Dresden
- [L69]**
Y. Mabuchi, T. Higuchi, V. Weinhacht
»Effect of sp²/sp³ Bonding Ratio and Nitrogen Content on Friction Properties of Hydrogen-Free DLC Coatings«
Tribology International 62 (2013), S. 29-36, S.130-140
- [L70] PRP**
A. Mahrle, S. Rose, E. Beyer, U. Füssel
»The Crucial Role of Beam Spot Position in Laser-Assisted Plasma Arc Welding«
Science and Technology of Welding and Joining, 2013
ISBN: 1743-2936
DOI:10.1179/1362171813Y.0000000173
- [L71] PRP**
A. Mahrle, S. Rose, M. Schnick, E. Beyer, U. Füssel
»Laser-Assisted Plasma Arc Welding of Stainless Steel«
Journal of Laser Applications 25 (2013), Nr. 3, Art. 032006
ISSN: 1042-346X
DOI: 10.2351/1.4798338
- [L72] PRP**
A. Mahrle, S. Rose, M. Schnick, E. Beyer, U. Füssel
»Stabilisation of Plasma Welding Arcs by Low Power Laser Beams«
Science and Technology of Welding and Joining 18 (2013), Nr. 4, S. 323-328
ISSN: 1362-1718
DOI:10.1179/1362171813Y.0000000109
- [L73]**
A. Majumder, M. Khazaei, J. Opitz, E. Beyer, L. Baraban, G. Cuniberti
»Bio-Functionalization of Multi-Walled Carbon Nanotubes«
Physical Chemistry Chemical Physics 15 (2013), Nr. 40, S. 17158-17164
DOI: 10.1039/C3CP51844B
- [L74]**
S. Makowski, V. Weihnacht, A. Leson
»Diesel-Lubricated ta-C Coatings«
Lubrication science 25 (2013), Nr. 4, S. 269-274
DOI: 10.1002/ls.1212
- [L75]**
M. Neuner
»Besser schmieren«
weiter.vorn Das Fraunhofer-Magazin Nr. 2/13, S. 46-47
- [L76] PRP**
S. Nowotny, F. Brückner, S. Thieme, C. Leyens, E. Beyer
»High Performance Laser Cladding with Combined Energy Sources«
Journal of Laser Applications 25 (2013), Nr. 5
- [L77]**
S. Nowotny, S. Thieme, D. Albert, F. Kubisch, R. Kager, C. Leyens
»Additive Manufacturing: Generieren, Reparieren und Oberflächenbeschichten mit dem Strahlwerkzeug Laser«
Tagungsband 6. TAW-Syposium »Thermisches Beschichten« Dresden, 10.-11.April 2013
- [L78]**
M. Oschatz, S. Thieme, Lars Borchardt, M. R. Lohe, T. Biemelt , J. Brückner, H. Althues, S. Kaskel
»A new route for the preparation of mesoporous carbon materials with high performance in lithium-sulphur battery cathodes«
CHEMICAL COMMUNICATIONS, 49 (2013) Nr. 52, S. 5832-5834
DOI: 10.1039/c3cc42841a
- [L79]**
J.-S. Pap, M. Kästner, S. Müller, I. Jansen
»Experimental Characterization and Simulation of the Mechanical Behavior of an Epoxy Adhesive for Bonding Textile-Reinforced Thermoplastic Composites«
Procedia Materials Science 2 (2013), S. 234-242
ISSN: 2211-8128
- [L80]**
T. Roch, A. Lasagni
»Direct Laser Interference Patterning of Tetrahedral Amorphous Carbon Thin Films«
Euromat 2013, 8.-13.09.13, Seville, Spanien, Tagungsband
- [L81]**
T. Roch, S. Eckhardt, H. Perez, D. Benke, J. Berger, A. Lasagni
»Direct Laser Interference Patterning (DLIP) für großflächige Mikrostrukturierung«
Bayerisches Lasersymposium 2013, Tagungsband
- [L82]**
T. Roch, V. Weihnacht, H.-J. Scheibe, A. Roch, A.-F. Lasagni
»Direct Laser Interfering Patterning of Tetrahedral Amorphous Carbon Films for Tribological Applications«
Diamond and Related Materials 33 (2013), S. 20-26
ISSN: 0925-9635
- [L83]**
S. Roling, S. Braun, P. Gawlitza, L. Samoylova, B. Siemer, H. Sinn, F. Siewert, F. Wahler, M. Wöstmann, H. Zacharias
»A Split- and Delay-Unit for the European XFEL«
Konferenz »Advances in X-Ray Free-Electron Lasers - Instrumentation«, in: Tschentscher, T.: »Advances in x-ray free-electron lasers: Instrumentation: 17-18 April 2013«, Prague, Czech Republic. Bellingham, (Proceedings of SPIE 8778), Paper 87781G
- [L84]**
S. Rose, A. Mahrle, M. Schnick, E. Beyer, U. Füssel
»Laserunterstützter Plasmalichtbogenprozess in koaxialer Anordnung – eine kombinierte Verfahrensvariante zum effizienten, schnellen und kostengünstigen Fügen«
9th International Conference Beam Technology, 24-25.04.2013, Halle (Saale), Tagungsband
- [L85] PRP**
S. Rose, A. Mahrle, M. Schnick, T. Pinder, E. Beyer, U. Füssel
»Plasma Welding with a Superimposed Coaxial Fiber Laser Beam«
Welding in the World, 57 (2013), Nr. 6, S. 857-865
ISSN: 0043-2288
DOI: 10.1007/s40194-013-0079-6
- [L86]**
M. Rühl, E. Pflug, S. Braun, A. Leson
»Cold Joining with Reactive Nanometer Multilayers (RMS)«
Geburtstagsschrift anlässlich 60. Geburtstag Prof. Gessner Fraunhofer ENAS

[L87]

R. Schedewy, B. Brenner, D. Dittrich, E. Beyer

»Multi-Pass-Narrow-Gap-Laser-Beam-Welding of Hot Crack Sensitive Aluminium Plates«

32nd International Congress on Applications of Lasers and Electro Optics, 6.-10.10.2013, Miami, USA, Tagungsband, Paper 1506
ISBN: 978-0-912035-98-7

[L88]

R. Schedewy, D. Dittrich, B. Brenner, E. Beyer

»Multi-Pass-Narrow-Gap-Laser-Beam-Welding of Hot Crack Sensitive Aluminium Plates«

6th International Congress on Laser Advanced Materials Processing, 23.-26.07.2013, Niigata, Japan, Tagungsband, #13-104

[L89]

N. Schilling, A.-F. Lasagni, U. Klotzbach

»Energy Dependent Processing of Fiber Reinforced Plastics with Ultra Short Laser Pulses«

Euromat 2013, 08.-13.09.13, Seville, Spanien, Tagungsband

[L90]

N. Schilling, A.-F. Lasagni, U. Klotzbach

»Energy Dependent Processing of Fibre Reinforced Plastics with Ultra Short Laser Pulses«

Lasers in Manufacturing Conference 2013, Physics Procedia 41 (2013), S. 414-420
DOI: 10.1016/j.phpro.2013.03.097
ISSN 1875-3892

[L91]

K. Schimek, M. Busek, S. Brickner, B. Groth, S. Hoffmann, R. Lauster, G. Lindner, A. Lorenz, U. Menzel, F. Sonntag, H. Walles, U. Marx, R. Horland

»Integrating Biological Vasculature into a Multi-Organ-Chip Microsystem«

Lab on a Chip 13 (2013) Nr.18, S. 3588-3598
DOI: 10.1039/C3LC50217A

[L92]

V. Schubert, A. Ostwaldt, M. Zimmermann, C. Leyens

»Phasenidentifizierung an hochlegierten Stählen - Farbätzmittel im Vergleich«

Metallographie-Tagung, 18.-20.09.2013, Friedrichshafen, Tagungsband: Praktische Metallographie, Sonderband 45 (2013), S. 67-74
ISBN: 978-3-883553-98-6

[L93]

S. Schulze, G. Göbel, V. Richter-Trummer, U. Füssel, E. Beyer

»The Influence of Gaps and Misalignment on Friction Stir Welded Butt Joints of Medium-Sized Parts«

Thermec 2013, 02.-06.12.2013, Las Vegas, USA, Tagungsband

[L94]

B. Schumm, S. Kaskel

Buchkapitel: »Nanoimprint Lithography for Photovoltaic Applications«

in: A. Tiwari, R. Boukherroub, M. Sharon, »Solar Cell Nanotechnology« (2013)
ISBN: 978-1-118-68625-6

[L95] PRP

L. D. Scintilla, L. Tricarico, A. Wetzig, E. Beyer

»Investigation on Disk and CO2 Laser Beam Fusion Cutting Differences Based on Power Balance Equation«

International Journal of Machine Tools and Manufacture 69 (2013), S. 30-37
ISSN: 0890-6955

[L96]

M. Seifert, K. Anhalt, C. Baltruschat, S. Bonß, B. Brenner

»Precise Temperature Calibration for Laser Heat Treatment«

SENSOR 2013, Nürnberg, 14.-16.05.2013, Tagungsband, S. 302-307
ISBN: 978-3-9813484-3-9

[L97]

M. Seifert, K. Anhalt, C. Baltruschat, S. Bonß, B. Brenner

»Qualitätsgesichertes Laserstrahlhärten durch mobile Temperaturkalibrierung (Quality assured laser heat treatment by mobile temperature)«

TEMPERATURE 2013, 05.-06.06.2013, Berlin, Tagungsband
ISBN: 3-9810021-8-0

[L98]

M. Sidorowicz, K. Sas, A. Klotzbach, J. Hauptmann, J. Reiner

»Machine Vision Aided Design for Remote Laser Processing«

14th Nordic Laser Materials Processing Conference, 26.-28.08.2013, Gothenburg, Sweden, Tagungsband, S. 347-358
ISBN 978-91-7439-688-1
ISBN 978-91-7439-689-8

[L99]

R. Siebert, E. Beyer

»Localized Neutron Grating Interferometry Investigation of Magnetic Bulk Property Deterioration of Electrical Steel«

3rd International Electric Drives Production Conference, 29.-30.10.2013, Nürnberg, Tagungsband

[L100]

J. Standfuß, U. Stamm, J. Bretschneider, G. Kirchhoff

»Laser Welded Cast Iron to Steel Joints for Differentials«

23rd Global Powertrain Congress, 29.-30.10.2013, Troy (MI), USA, Tagungs-CD

[L101]

S. Stelzer, A. Mahrle, A. Wetzig, E. Beyer

»Experimental Investigations on Fusion Cutting Stainless Steel with Fibre and CO2 Laser Beams«

WLT-Konferenz Lasers in Manufacturing LiM 2013, 13.-16.05.2013 München, Tagungsband

[L102]

S. Stelzer, A. Mahrle, A. Wetzig, E. Beyer

»Experimental Investigations on Fusion Cutting Stainless Steel with Fibre and CO2 Laser Beams«

Physics Procedia 41 (2013), S. 392-397
ISSN: 1875-3892
DOI: 10.1016/j.phpro.2013.03.083

[L103]

G. Theiler, T. Gradt, W. Österle, A. Brückner, V. Weihnacht

»Friction and Endurance of MoS2/ta-C Coatings Produced by Laser Arc Deposition«

Wear 297 (2013), Nr.1-2, S.791-801
ISSN: 0043-1648

[L104]

S. Thieme, J.Brückner, I. Bauer, M. Oschatz, L. Borchardt, H. Althues, S. Kaskel

»High capacity micro-mesoporous carbon-sulfuranocomposite cathodes with enhanced cycling stability prepared by a solvent-free procedure«

Journal of Materials Chemistry A, 1 (2013) Nr. 32, S. 9225-9234
DOI: 10.1039/c3ta10641a

[L105]

F.-L. Toma, S. Scheitz, L.-M. Berger, S. Thiele, T. Kuntze, U. Klotzbach, G. Kirchhoff

»Beschichtbarkeit keramischer Substrate durch thermisches Spritzen«

16. Werkstofftechnischen Kolloquium 2013, 26.-27.09.13, Chemnitz, Tagungsband

[L106]

A. Wagner, M. Lütke, A. Wetzig, L. M. Eng

»Laser Remote-Fusion Cutting with Solid State Lasers«

Journal of Laser Applications 25 (2013), Nr. 5
DOI: 10.2351711.4816651

[L107]

I. Wagner, E.-M. Materne, S. Brickner, U. Süßbier, C. Frädrieh, M. Busek, F. Sonntag, D. A. Sakharov, E. V. Tushkin, A. G. Tonevitsky, R. Lauster, U. Marx

»A Dynamic Multi-Organ-Chip for Long-Term Cultivation and Substrate Testing Proven by 3D Human Liver and Skin Tissue Co-Culture«

Lab Chip 13 (2013), Nr. 18, S. 3538-3547
ISSN: 1473-0197
DOI: 10.1039/c3lc50234a

[L108]

K. Wagner, S. Friedrich, C. Stang, T. Bley, N. Schilling, M. Bieda, A. Lasagni, E. Boschke

»Initial Phases of Microbial Biofilm Formation on Opaque, Innovative Anti-Adhesive Surfaces Using a Modular Microfluidic System«

Engineering in Life Sciences 2013, Early View
ISSN: 1618-2863
DOI: 10.1002/elsc.201200035

[L109]

M. Wagner

»Autos - leicht und crashsicher«

Forschung Kompakt, 08/2013, Thema 5

[L110]

M. Wagner

»Autos - leicht und crashtsicher«

Laser Magazin, Ausgabe 4, September 2013, S. 55-56

[L111]

M. Wagner

»Kopplung thermischer und mechanischer Lasten in PAM-CRASH«

ESI DACH Forum, 5.-6.11.2013, Wiesbaden, Tagungsband

[L112]

M. Wagner

»Laser Welded Light Weight Profiles in Integral Multi-Material Constructions«

Automotive Engineering Congress, 5.6.2013, Nürnberg, Tagungsband

[L113]

M. Wagner

»Laserverfestigte Fahrzeugcrashstrukturen«

wt Werkstatttechnik online, Jahrgang 103, (2013) H.6, S. 485-487

[L114]

M. Wagner

»Lokale Verfestigung von Stahlblechen als Leichtbautechnik«

Maschinenmarkt 40 (2013), S. 34-35
ISSN: 03415775**[L115]**

M. Wagner

»Simulation des Verformungsverhaltens laserverfestigter Karosseriestrukturen«

Zeitschrift für Freunde und Förderer der Technischen Universität Bergakademie Freiberg, 20. Jahrgang 2013

[L116]

A. Wank, F. Beck, T. Schlaefer, S. Nowotny, F. Brueckner, H. Hillig, M. Pfennig, S. Thieme

»Capability of Combined Thermal Spray & Laser Coating Centers to Improve Production Efficiency«

Thermal Spray Bulletin 6 (2013), Nr. 1, S. 22-29

[L117]

V. Weihnacht

»Tribology of Hard Carbon Coatings under Ultra- and Super-Low Friction Conditions«

40th International Conference on Metallurgical Coatings and Thin Films, 29.04.-03.05.2013, San Diego, California
ISSN: 0257-8972**[L118]**

V. Weihnacht, S. Makowski, A. Leson

»Fundamental Aspects in Friction and Wear Mechanisms of Hard Amorphous Carbon Coatings«

World Tribology Congress 2013, 8-13.09.2013, Turin, Italien, Tagungsband

[L119]

A. Wetzig

»Development in Beam Scanning (Remote) Technologies and Smart Beam Processing«

in: »Handbook of laser welding technologies«, S. Katayama, 2013, S. 422-433
ISBN: 978-0-85709-264-9
DOI:10.1533/9780857098771.3.422**[L120]**

A. Wetzig

»Remote-Laserstrahlschneiden«

DVS-Congress, 07.09.2013, Essen, Beitrag 3583

[L121]

C. Winkelmann, Y. Luo, A. Lode, M. Gelinsky, U. Marx, M. Busek, F. Schmieder, F. Sonntag

»Charakterisierung von in Lab-on-a-Chip System eingebetteten Hohlfasern«

tm - Technisches Messen; Plattform für Methoden, Systeme und Anwendungen der Messtechnik, Band 80 (2013), Nr. 5, S. 147-154
ISSN: 0171-8096
DOI: 10.1524/teme.2013.0024**[L122]**

O. Zimmer

»Verschleißschutz für extreme Belastungen«

WirtschaftsJournal - Das mitteldeutsche Wirtschaftsmagazin, Nr. 8/2013, S.3
ISSN: 1617-6669**[L123]**

O. Zimmer, F. Kaulfuß

»Dicke Hartstoffschichten für extrem belastete Oberflächen«

V2013 Industrieausstellung & Workshop-Woche Vakuumbeschichtung und Plasmaoberflächentechnik, 14.-17.10.13, Dresden, Tagungsband, S. 70

[L124]

M. Zimmermann, A. Grigorescu, C. Müller-Bollenhagen, H.-J. Christ

»Influence of Deformation-Induced Alpha Prime Martensite on the Crack Initiation Mechanism in a Metastable Austenitic Steel in the HCF and VHCF Regime«

13th International Conference on Fracture, Beijing, China, 16.-21. Juni 2013, Tagungsband und Tagungs-CD

[L125]

M. Zimmermann, A. Kolyshkin, C. Stöcker, J. W. Jones, H.-J. Christ

»Damage Evolution and Crack Growth in Nickel-Based Alloys during Ultrasonic Fatigue«

Thermec 2013, 02.-06.12. 2013, Las Vegas, USA, Tagungsband

[L126]

M. Zimmermann, A. Kolyshkin, C. Stöcker, M. Cremer, H.-J. Christ

»Ermüdungsverhalten teilgehärteter Legierungen im Bereich niedriger und sehr hoher Lastspielzahlen«

Werkstoffprüfung 2013, 28.-29.11.2013, Neu-Ulm, Tagungsband

ADDRESS AND DIRECTIONS



by car (from Autobahn / Highway)

- take Autobahn A4 or A13 to intersection Dresden-West, follow new Autobahn A17 to exit Südvorstadt / Zentrum
- follow road B170 in direction Stadtzentrum (city center) to Pirnaischer Platz (about 6 km)
- at Pirnaischer Platz turn right towards "Gruna / VW-Manufaktur"
- continue straight until the end of the "Großer Garten" (Great Garden) and then turn right onto Karcherallee
- at the next traffic light turn left onto Winterbergstraße and continue straight until IWS

by railway and tram

- from Dresden main railway station take line #10 to Straßburger Platz
- change to line #1 (Prohlis) or #2 (Kleinzschachwitz) heading out from the city; exit at Zwinglistraße stop
- 10 minutes to walk from there (in the direction of Grunaer Weg)

by air plane

- from Airport Dresden-Klotzsche with a taxi to Winterbergstraße 28 (about 10 km)
- or with public transportation (shuttle train) to the main railway station (Hauptbahnhof), and continue with the tram

Address:

Fraunhofer-Institut für Werkstoff- und Strahltechnik IWS Dresden
(Fraunhofer Institute for Material and Beam Technology)

Winterbergstr. 28
01277 Dresden

Internet-Adresse:

www.iws.fraunhofer.de

phone +49 351 83391-0

fax +49 351 83391-3300

e-mail info@iws.fraunhofer.de

Editorial staff /
coordination / editing:

B.Eng. Sophie Pianski
Dr. Anja Techel
Dr. Ralf Jäckel

Photos:

S. 2, 14, 86	Shutterstock.com / Frank Höhler
S. 5, 9, 13, 29, 33, 42, 100, 103, 114, 140, 142 (u.)	Frank Höhler
S. 6	Joachim Blobel
S. 8 (top l.)	Sempa Systems GmbH
S. 8 (top r.)	Rubotherm GmbH
S. 11	Dr. F. Junker (privat)
S. 18	DDpix.de, Marcel Quietzsch / Frank Höhler
S. 20, 40, 54, 55, 68, 104	Fraunhofer IWS / Frank Höhler
S. 22, 56, 70, 88, 106	Jürgen Jeibmann
S. 25	Jonas & Redmann
S. 44 (Fig. 2)	Federal-Mogul Burscheid GmbH
S. 49	Fraunhofer IWU
S. 62, 63	TU Dresden
S. 64, 65 (Fig. 2)	TU Chemnitz
S. 74	Alstom
S. 76	Wikipedia Commons
S. 128, 129	TU Wrocław
S. 132	Reiner Sprengel
S. 134, 135	Fraunhofer IPM, ILT, IST, IOF, FEP
S. 136 (top l.)	TU Dresden, Ulrich van Stipriaan
S. 142 (top r.)	Deutsche Gesellschaft für Materialkunde (DGM)
all other pictures	Fraunhofer IWS

© Fraunhofer-Institut für Werkstoff- und Strahltechnik IWS Dresden 2014

Reprints require permission of the editor.